

# Lifting Capacities

Telescopic Boom Rough Terrain Crane

## RTC-80100

100-ton (91 metric tons)

### Series II

Boom and Fly Capacities for this machine are listed by the following sections.

#### Fully Extended Outriggers

- Working Range Diagram
- 24,000 lbs (10 886 kg) of Counterweight
- 40' to 95' (12.19 – 28.96 m) Main Boom Capacities, "A-max1" Mode
- 40' to 122.5' (12.19 – 37.34 m) Main Boom Capacities, "A-max2" Mode
- 40' to 150' (12.19 – 45.72 m) Main Boom Capacities, "Standard" Mode
- 31' to 85' (9.45 – 25.90 m) Fly Capacities, "Standard" Mode

#### On Tires

- With Outrigger Boxes
- Stationary – Over Rear, Stationary – 360°, Creep and 2.5 mph
- 24,000 lbs (10 886 kg) of Counterweight
- 40' to 95' (12.19 – 28.96 m) "A-max1" Boom Mode
- 40' to 122.5' (12.19 – 37.34 m) Main Boom Capacities, "A-max2" Mode
- 40' to 120' (12.19 – 36.58 m) Main Boom Capacities, "Standard" Mode

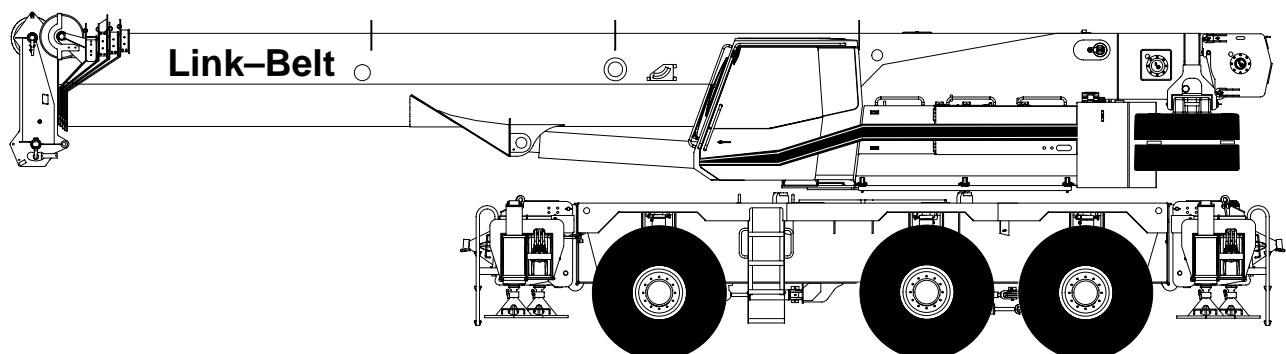

**CAUTION: This material is supplied for reference use only. Operator must refer to in-cab Crane Rating Manual to determine allowable machine lifting capacities and operating procedures.**



## WARNING

**READ AND UNDERSTAND THE OPERATOR'S AND SAFETY MANUALS AND THE FOLLOWING INSTRUCTIONS AND RATED LIFTING CAPACITIES BEFORE OPERATING CRANE. OPERATION WHICH DOES NOT FOLLOW THESE INSTRUCTIONS MAY RESULT IN AN ACCIDENT**

## OPERATING INSTRUCTIONS

### GENERAL:

1. Rated lifting capacities in pounds as shown on lift charts pertain to this crane as originally manufactured and normally equipped. Modifications to the crane or use of optional equipment other than that specified can result in a reduction of capacity.
2. Construction equipment can be dangerous if improperly operated or maintained. Operation and maintenance of this crane must be in compliance with the information in the Operator's, Parts, and Safety Manuals supplied with this crane. If these manuals are missing, order replacements through the distributor.
3. The operator and other personnel associated with this crane shall read and fully understand the latest applicable American National Standards ASME B30.5 safety standards for cranes.
4. The rated lifting capacities are based on crane standing level on firm supporting surface.

### SET UP:

1. The crane shall be leveled on a firm supporting surface. Depending on the nature of the supporting surface, it may be necessary to have structural supports under the outrigger pontoons or tires to spread the load to a larger bearing surface.
2. When making lifts on outriggers, all tires must be free of supporting surface. All outrigger beams must be extended to the same length; fully retracted, intermediate extended, or fully extended.
3. The tires must be inflated to 102 psi for all travel and when making lifts on tires.
4. For required parts of line, see Wire Rope Capacity and Winch Performance.
5. Before setting up the crane, refer to Allowable Crane Configuration and rated lifting capacities to determine allowable crane configurations.

### OPERATION:

1. Rated lifting capacities at rated radii shall not be exceeded. Do not tip the crane to determine allowable loads.
2. Rated lifting capacities shall be reduced for repetitive lift applications. For concrete bucket operation, weight of bucket and load shall not exceed 80% of rated load.

For duty cycle operation, such as loading and unloading, maximum allowable load shall not exceed 70% of rated load. For clamshell and magnet operation, weight of bucket, or magnet, and load shall not exceed 70% of rated load. Lifts with fly erected are prohibited for clamshell and magnet operation.

3. Rated lifting capacities shown on fully extended outriggers do not exceed 85% of the tipping loads. Rated lifting capacities shown on intermediate extended or fully retracted outriggers are determined by the formula, rated load = (tipping load – 0.1 X load factor) / 1.25. Rated lifting capacities shown on tires do not exceed 75% of the tipping loads. Tipping loads are determined by SAE crane stability test code J-765.
4. Rated lifting capacities in the shaded areas are based on structural strength or hydraulic limitations and have been tested to meet minimum requirements of SAE J-1063 cantilevered boom crane structures—method of test. Rated lifting capacities in the non-shaded areas are based on stability ratings.
5. Rated lifting capacities include the weight of hook ball/block, slings, bucket, magnet, and auxiliary lifting devices. Their weights must be subtracted from the listed rated capacity to obtain the net load that can be lifted. Rated lifting capacities include the deduct for either fly stowed on the base of the boom. For deducts of any fly erected, but not used, see Capacity Deductions.
6. Rated lifting capacities are based on freely suspended loads. No attempt shall be made to move a load horizontally on the ground in any direction.
7. Rated lifting capacities are for lift crane service only.
8. Do not operate at radii or boom lengths (minimum or maximum) where capacities are not listed. At these positions, the crane can tip or cause boom failure.
9. The maximum loads that can be telescoped are not definable because of variation in loadings and crane maintenance, but it is permissible to attempt retraction and extension within the limits of the applicable load rating chart.
10. For main boom capacities when either boom length or radius or both are between values listed, proceed as follows:
  - a. For boom lengths not listed, use rating for next longer boom length or next shorter boom length, whichever is smaller.
  - b. For load radii not listed, use rating for next larger radius.

11. The user shall operate at reduced ratings to allow for adverse job conditions, such as: soft or uneven ground, out of level conditions, wind, side loads, pendulum action, jerking or sudden stopping of loads, hazardous conditions, experience of personnel, traveling with loads, electrical wires, etc. Side load on boom or fly is dangerous and shall be avoided.
12. For cold weather operation rated capacities should be reduced by the following rule: a 1% reduction in rated capacity should be taken for each 1°F below 0°F. Example: if the temperature is -10°F a 10% reduction in rated capacities should be taken, at -40°F a 40% reduction.
13. When making lifts with auxiliary lifting sheave, the effective length of the boom increases by 2 feet.
14. The power sections of the boom, for the selected boom mode, must be extended or retracted equally.
15. The least stable rated working area depends on the configuration of the crane set up.
16. Rated lifting capacities are based on correct reeving. Deduction must be made for excessive reeving. Any reeving over minimum required is considered excessive and must be accounted for when making lifts. Use Working Range Diagram to estimate the extra feet of rope then deduct 1.5 lb for each extra foot of wire rope before attempting to lift a load.
17. The loaded boom angle combined with the boom length give only an approximation of the operating radius. The boom angle, before loading, should be greater to account for deflection. For main boom capacities, the loaded boom angle is for reference only. For fly capacities, the load radius is for reference only.
18. For fly capacities with main boom length between 120 ft. and 150 ft., the rated loads are determined by the boom angle using the 150 ft. boom and fly chart. For angles not shown use the next lower boom angle to determine the rated capacity.
19. For fly capacities with main boom length less than 120 ft. the rated loads are determined by the boom angle only using the 120 ft. boom and fly chart. For angles not shown, use the next lower boom angle to determine the rated capacity.
20. The 40 ft. boom length structural capacities are based on boom fully retracted. If the boom is not fully retracted, do not exceed capacities shown for the 50 ft. boom length.
21. Rated lifting capacities on tires depend on tire capacity, condition of tires, and tire air pressure. On tire capacities require lifting from main boom head only on a smooth and level surface. Pick and carry operations are restricted to speed of 2.5 mph and creep. The boom must be centered over the rear of the crane with two-position travel swing lock engaged and the load must be restrained from swinging. Lifts with any fly erected on tires are prohibited.

**DEFINITIONS:**

1. Load Radius: Horizontal distance from a projection of the axis of rotation to the supporting surface, before loading, to the center of the vertical hoist line or tackle with load applied.
2. Loaded Boom Angle:  $\angle$  The angle between the boom base section and horizontal with freely suspended load at the rated radius.
3. Working Area: Area measured in a circular arc about the center line of rotation as shown on the Working Area Diagram.
4. Freely Suspended Load: Load hanging free with no direct external force applied except by the hoist line.
5. Side Load: Horizontal side force applied to the lifted load either on the ground or in the air.
6. No Load Stability Limit: The radius or boom angle beyond which it is not permitted to position the boom because the crane can overturn without any load on the hook.
7. Load Factor: Load applied at the boom tip which gives the same moment effect as the boom mass.
8. Creep: Crane movement limited to 200 ft. in a 30 minute period and not to exceed 1 mph maximum speed.

## BOOM MODES

### Boom Mode "Amax1"

Inner and center sections telescope simultaneously.

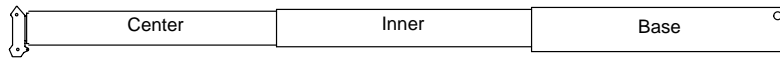

Telescope Length (Ft.)		Boom Length (Ft.)
0	0	40
5.0	5.0	50
10.0	10.0	60
15.0	15.0	70
20.0	20.0	80
25.0	25.0	90
27.5	27.5	95

### Boom Mode "Amax2"

Center, outer, and tip sections telescope simultaneously.

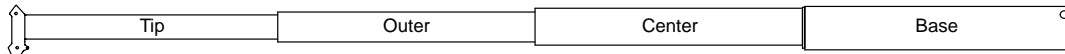

Telescope Length (Ft.)			Boom Length (Ft.)
0	0	0	40
3.33	3.33	3.33	50
6.66	6.66	6.66	60
10.00	10.00	10.00	70
13.33	13.33	13.33	80
16.66	16.66	16.66	90
20.00	20.00	20.00	100
23.33	23.33	23.33	110
27.50	27.50	27.50	122.5

### Boom Mode "Standard"

Inner, center, outer, and tip sections telescope simultaneously.

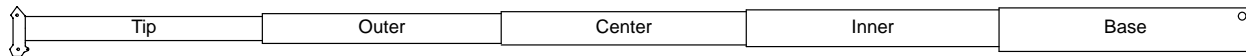

Telescope Length (Ft.)				Boom Length (Ft.)
0	0	0	0	40
2.5	2.5	2.5	2.5	50
5.0	5.0	5.0	5.0	60
7.5	7.5	7.5	7.5	70
10.0	10.0	10.0	10.0	80
12.5	12.5	12.5	12.5	90
15.0	15.0	15.0	15.0	100
17.5	17.5	17.5	17.5	110
20.0	20.0	20.0	20.0	120
22.5	22.5	22.5	22.5	130
25.0	25.0	25.0	25.0	140
27.5	27.5	27.5	27.5	150

## ALLOWABLE CRANE CONFIGURATION

		Amax1	Amax2	STD	31'	55'	70'	85'
ON TIRES	0 lbs.	-	40'-80'	-	-	-	-	-
	12,000 lbs.	40'-95'	40'-122.5'	40'-120'	-	-	-	-
	24,000 lbs.	40'-95'	40'-122.5'	40'-120'	-	-	-	-
RETRACTED	0 lbs.	-	40'-100'	-	-	-	-	-
	12,000 lbs.	40'-95'	40'-122.5'	40'-120'	-	-	-	-
	24,000 lbs.	40'-95'	40'-122.5'	40'-120'	-	-	-	-
INTERMEDIATE	0 lbs.	-	-	-	-	-	-	-
	12,000 lbs.	40'-95'	40'-122.5'	40'-150'	-	-	-	-
	24,000 lbs.	40'-95'	40'-122.5'	40'-150'	40'-150'	-	-	-
FULL	0 lbs.	-	-	-	-	-	-	-
	12,000 lbs.	40'-95'	40'-122.5'	40'-150'	40'-150'	40'-150'	-	-
	24,000 lbs.	40'-95'	40'-122.5'	40'-150'	40'-150'			

## WIND SPEED RESTRICTIONS

If The Wind Speed Exceeds:	Rated Lifted Capacities Must Be Reduced By At Least:
20 MPH	40%
30 MPH	70%
40 MPH	Crane operation must be shutdown and the boom retracted and lowered to horizontal.

- Additional reductions are required for loads with large wind sail area.
- These restrictions are based on crane on fully extended outriggers. Additional reductions are required for other configurations.
- During high winds, the operator shall add 10° to all minimum boom angles due to no load stability and shall not boom down below that angle.

## WINCH PERFORMANCE

Wire Rope Layer	Winch Line Pulls		Drum Rope Capacity (ft.)	
	Two Speed Winch			
	Low Speed Available lb*	High Speed Available lb	Layer	Total
1	21,022	9,474	125	125
2	18,968	8,549	138	263
3	17,280	7,788	152	415
4	15,868	7,151	165	580
5	14,669	6,611	179	759
6	13,639	6,147	192	951

\* Maximum lifting capacity: Type RB Rope = 17,520 Type ZB Rope = 20,920

## WIRE ROPE CAPACITY

Maximum Lifting Capacities Based On Wire Rope Strength			
Parts of Line	7/8"	7/8"	Notes
	Type RB	Type ZB	
1	17,520	20,920	Capacities shown are in pounds and working loads must not exceed the ratings on the capacity charts in the Crane Rating Manual. Capacity deducts for auxiliary lifting devices do not apply for wire rope strength capacities. Study Operator's Manual for wire rope inspection procedures and single part of line applications.
2	35,040	41,840	
3	52,560	67,760	
4	70,080	83,680	
5	87,600	104,600	
6	105,120	125,520	
7	122,640	146,440	
8	140,160	167,360	
9	157,680	188,280	
10	175,200	209,200	
11	192,720	230,120	
12	210,240	251,040	

LBCE	DESCRIPTION
TYPE RB	18 X 19 Rotation Resistant – Compacted Strand – High Strength, Preformed, Right Regular Lay
TYPE ZB	36 X 7 Rotation Resistant – Extra Improved Plow Steel – Right Regular Lay

## HYDRAULIC CIRCUIT PRESSURE SETTINGS

Function	Pressure (psi)
Front and Rear Winch (Non-Adjustable)	4,130 – 4,350
Propel (Non-Adjustable)	6,090 – 6,310
Outrigger/Counterweight Removal (Option)	3,000
Boom Hoist/Telescope Retract	4,400
Telescope/Extend	3,000
Swing/Steering	3,000
Pilot Control	500
Charge Circuit	350
Park Brake	350

## CAPACITY DEDUCTIONS

Load Handling Equipment	Weight (lb)
80 Ton Quick Reeve 5 Sheave Hook Block (See Hook Block For Actual Weight)	1,410
100 Ton Quick Reeve 6 Sheave Hook Block (See Hook Block For Actual Weight)	1,750
12 Ton Hook Ball (See Hook Ball For Actual Weight)	720

Auxiliary Lifting Devices	Weight (lb)
Auxiliary Head Attached	100
<b>Lifting From Main Boom With:</b>	
31 Ft. Or 55 Ft. Fly Stowed On Boom Base (See Operation Note 4)	0
31 Ft. Offset Fly Erected But Not Used	4,600
55 Ft. Offset Fly Erected But Not Used	7,500
70 Ft. Offset Fly Erected But Not Used	PROHIBITED
85 Ft. Offset Fly Erected But Not Used	PROHIBITED
<b>Lifting From 31 Ft. Offset Fly With:</b>	
24 Ft. Fly Tip Erected But Not Used	PROHIBITED
24 Ft. Fly Tip Stowed On 31 Ft. Offset Fly	PROHIBITED

**Note: Capacity deductions are for Link-Belt supplied equipment only.**

## WORKING AREAS

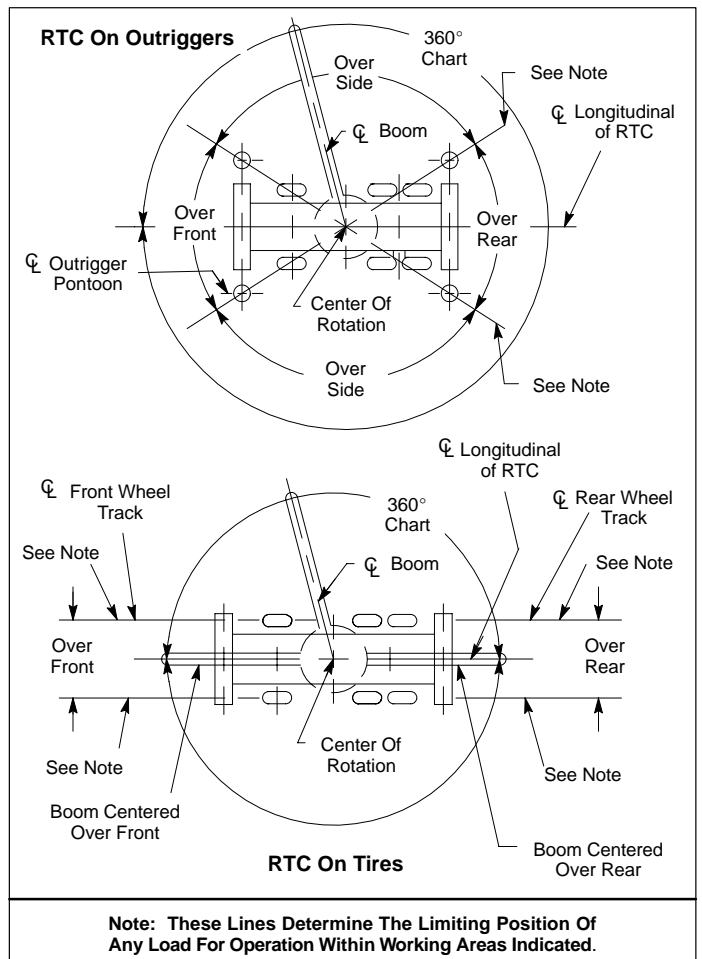

## WORKING RANGE DIAGRAM

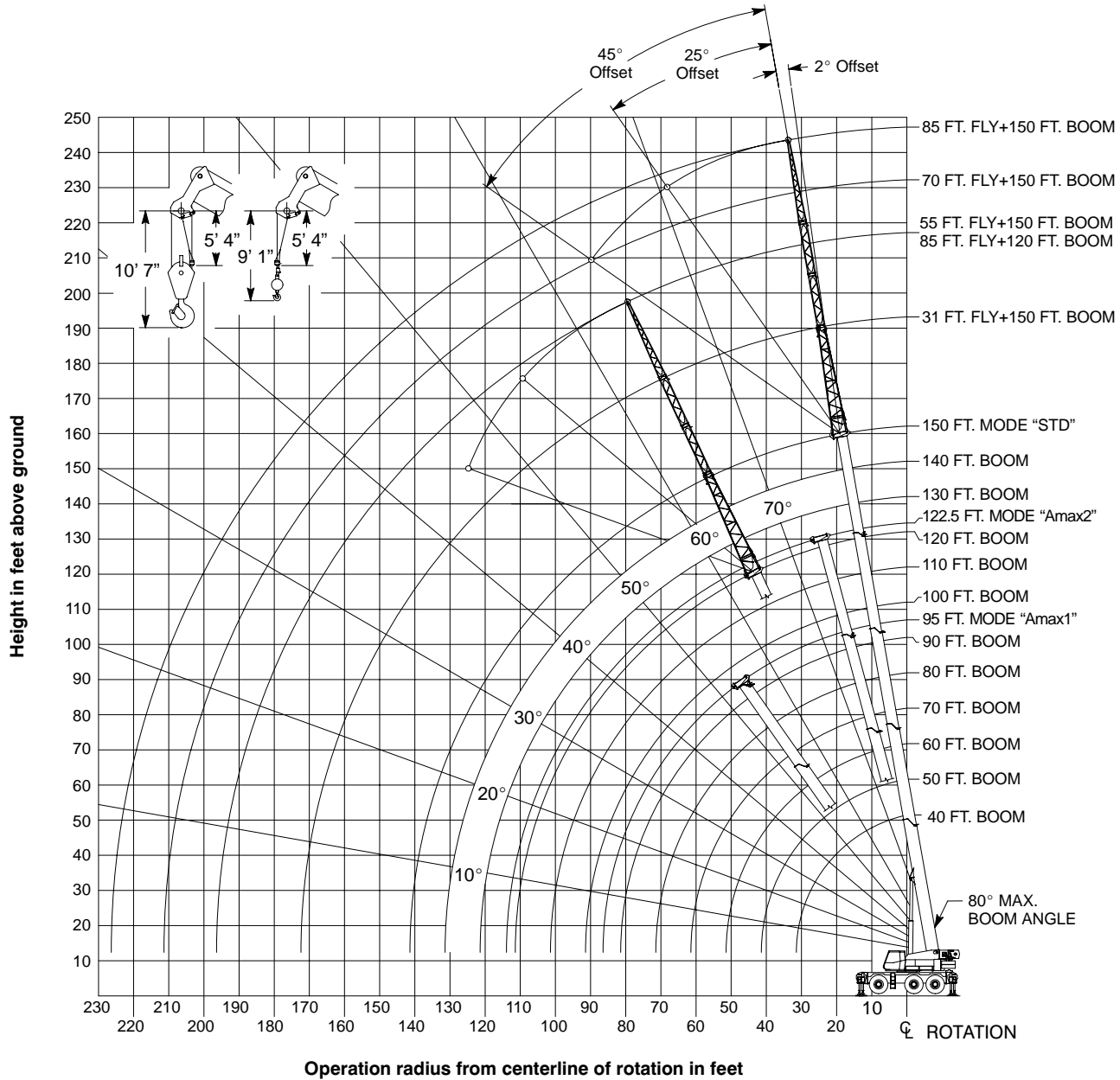

**Note:** Boom and fly geometry shown are for unloaded condition and crane standing level on firm supporting surface. Boom deflection, subsequent radius, and boom angle change must be accounted for when applying load to hook.

### **WARNING**

**Do Not Lower The Boom Below The Minimum Boom Angle For No Load Stability As Shown In The Lift Charts For The Boom Lengths Given. Loss Of Stability Will Occur Causing A Tipping Condition.**

**Rated Lifting Capacities  
In Pounds**

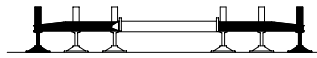

Full

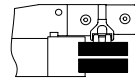

24,000# Counterweight

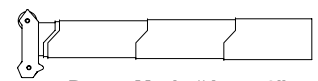

Boom Mode "Amax1"

Load Radius (Ft)	40 Ft.			50 Ft.		
	∠°	360°	Front	∠°	360°	Front
10	68.0	200,000	200,000	72.5	104,100	104,100
12	64.5	182,500	183,100	70.0	104,100	104,100
15	59.5	158,300	158,800	66.5	104,100	104,100
20	50.0	122,200	122,200	60.0	104,100	104,100
25	39.0	94,900	94,900	52.5	94,400	94,400
30	21.5	76,600	76,600	44.5	76,100	76,100
35				34.0	61,200	61,900
40				19.0	47,300	47,900
45						
50						
55						
60						
Min.Bm. Ang./Cap.	0 (31.5)	50,700	50,700	0 (41.5)	38,000	38,000
Load Radius (Ft)	60 Ft.			70 Ft.		
	∠°	360°	Front	∠°	360°	Front
10	76.0	102,500	102,500	78.5	101,500	101,500
12	74.0	102,500	102,500	76.5	101,500	101,500
15	71.0	102,500	102,500	74.0	101,500	101,500
20	66.0	102,500	102,500	70.0	95,200	95,200
25	60.0	93,900	93,900	65.5	81,100	81,100
30	54.0	75,800	75,800	60.5	70,300	70,300
35	47.5	60,400	61,200	55.5	59,900	60,600
40	40.0	46,900	47,500	50.0	46,400	47,000
45	31.0	37,500	38,000	44.0	37,100	37,600
50	17.0	30,500	31,000	37.0	30,300	30,700
55				28.5	25,100	25,500
60				15.5	20,900	21,200
Min.Bm. Ang./Cap.	0 (51.5)	28,800	28,900	0 (61.5)	19,800	20,100

Load Radius (Ft)	80 Ft.			90 Ft.		
	∠°	360°	Front	∠°	360°	Front
12	79.0	100,100	100,100			
15	76.5	88,800	88,800	78.5	81,900	81,900
20	73.0	74,300	74,300	75.5	69,900	69,900
25	69.0	63,500	63,500	72.0	59,800	59,800
30	65.0	55,000	55,000	68.5	51,700	51,700
35	61.0	48,200	48,200	65.0	45,300	45,300
40	56.5	42,800	42,800	61.5	40,100	40,100
45	52.0	36,700	37,200	57.5	35,600	35,600
50	47.0	30,000	30,400	53.5	29,700	30,200
55	41.0	24,800	25,200	49.0	24,600	24,900
60	34.5	20,700	21,100	44.0	20,500	20,800
65	27.0	17,400	17,700	39.0	17,300	17,500
70	14.5	14,700	14,900	33.0	14,600	14,900
75				25.5	12,200	12,500
80				14.0	10,300	10,500
Min.Bm. Ang./Cap.	0 (71.5)	13,900	14,200	0 (81.5)	9,700	9,900
Load Radius (Ft)	95 Ft.					
	∠°	360°	Front			
12						
15						
20	76.5	61,800	61,800			
25	73.5	57,400	57,400			
30	70.0	49,700	49,700			
35	67.0	43,500	43,500			
40	63.5	38,400	38,400			
45	60.0	34,200	34,200			
50	56.0	29,600	30,100			
55	52.0	24,500	24,800			
60	47.5	20,400	20,700			
65	43.0	17,200	17,400			
70	38.0	14,500	14,800			
75	32.0	12,200	12,500			
80	25.0	10,200	10,500			
Min.Bm. Ang./Cap.	0 (86.5)	8,000	8,300			

( ) Reference Radius For Minimum Boom Angle Capacities (Shown In Parenthesis) Are In Feet.

∠° Loaded Boom Angle In Degrees.

## Rated Lifting Capacities In Pounds

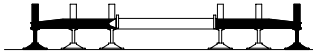

Full

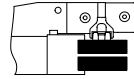

24,000# Counterweight

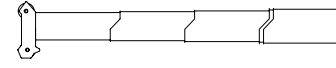

Boom Mode "Amax2"

Load Radius (Ft)	40 Ft.			50 Ft.		
	∠°	360°	Front	∠°	360°	Front
10	68.0	200,000	200,000	72.5	52,000	52,000
12	64.5	182,500	183,100	70.0	52,000	52,000
15	59.5	158,300	158,800	66.5	52,000	52,000
20	50.0	122,200	122,200	60.0	52,000	52,000
25	39.0	94,900	94,900	52.5	52,000	52,000
30	21.5	76,600	76,600	44.0	52,000	52,000
35				34.0	52,000	52,000
40				19.0	49,800	50,400
45						
50						
55						
60						
Min.Bm. Ang./Cap.	0 (31.5)	50,700	50,700	0 (41.5)	33,300	33,300
Load Radius (Ft)	60 Ft.			70 Ft.		
	∠°	360°	Front	∠°	360°	Front
10	75.5	52,000	52,000	78.0	52,000	52,000
12	74.0	52,000	52,000	76.5	52,000	52,000
15	71.0	52,000	52,000	74.0	52,000	52,000
20	65.5	52,000	52,000	70.0	52,000	52,000
25	60.0	52,000	52,000	65.5	52,000	52,000
30	54.0	52,000	52,000	60.5	52,000	52,000
35	47.5	52,000	52,000	55.5	52,000	52,000
40	40.0	51,000	51,600	50.0	51,700	52,000
45	31.0	41,400	41,900	44.0	42,000	42,500
50	17.0	34,300	34,700	37.0	35,000	35,400
55				28.5	29,600	30,000
60				15.5	25,300	25,700
Min.Bm. Ang./Cap.	0 (51.5)	23,800	23,800	0 (61.5)	18,200	18,200
Load Radius (Ft)	80.0 Ft.			90.0 Ft.		
	∠°	360°	Front	∠°	360°	Front
12	78.0	53,200	53,200			
15	76.5	53,200	53,200	78.0	54,500	54,500
20	73.0	53,200	53,200	75.0	54,500	54,500
25	69.0	53,200	53,200	71.5	54,500	54,500
30	65.0	53,200	53,200	68.5	54,500	54,500
35	61.0	53,200	53,200	65.0	50,300	50,300
40	56.5	52,100	52,600	61.0	45,500	45,500
45	51.5	42,400	42,900	57.0	41,400	41,400
50	46.5	35,400	35,800	53.0	35,700	36,100
55	41.0	30,100	30,500	48.5	30,400	30,800
60	34.5	25,800	26,200	44.0	26,100	26,500
65	26.5	22,400	22,700	38.5	22,700	23,000
70	14.5	19,500	19,800	32.5	19,900	20,200
75				25.0	17,500	17,700
80				14.0	15,500	15,700
85						
90						
Min.Bm. Ang./Cap.	0 (71.5)	14,200	14,200	0 (81.5)	11,300	11,300

Load Radius (Ft)	100 Ft.		
	∠°	360°	Front
12			
15	79.5	56,000	56,000
20	77.0	56,000	56,000
25	74.0	53,700	53,700
30	71.0	47,500	47,500
35	68.0	42,400	42,400
40	64.5	38,300	38,300
45	61.5	34,800	34,800
50	58.0	31,800	31,800
55	54.5	29,300	29,300
60	50.5	26,400	26,700
65	46.5	22,900	23,200
70	42.0	20,100	20,400
75	37.0	17,700	18,000
80	31.0	15,800	16,000
85	24.0	14,000	14,300
90	13.5	12,500	12,700
Min.Bm. Ang./Cap.	0 (91.5)	9,100	9,100

Load Radius (Ft)	110 Ft.			122.5 Ft.		
	∠°	360°	Front	∠°	360°	Front
20	78.5	55,300	55,300			
25	76.0	49,100	49,100	77.5	37,800	37,800
30	73.0	43,500	43,500	75.5	37,800	37,800
35	70.5	38,900	38,900	73.0	35,300	35,300
40	67.5	35,100	35,100	70.5	31,900	31,900
45	64.5	31,900	31,900	68.0	29,000	29,000
50	61.5	29,100	29,100	65.5	26,500	26,500
55	58.5	26,700	26,700	62.5	24,300	24,300
60	55.5	24,700	24,700	60.0	22,400	22,400
65	52.0	22,800	22,800	57.0	20,700	20,700
70	48.0	20,300	20,500	54.0	19,200	19,200
75	44.5	17,900	18,100	51.0	17,800	17,800
80	40.0	16,000	16,200	47.5	16,200	16,400
85	35.5	14,200	14,500	44.0	14,400	14,600
90	30.0	12,700	12,900	40.5	12,900	13,100
95	23.0	11,400	11,600	36.0	11,600	11,800
100	13.0	10,200	10,400	31.5	10,400	10,600
105				25.5	9,300	9,500
110				18.0	8,400	8,500
Min.Bm Ang/Cap	0 (101.5)	7,400	7,400	0 (114.0)	5,800	5,800



**Rated Lifting Capacities  
In Pounds**

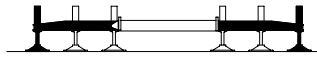

Full

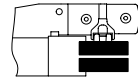

24,000# Counterweight

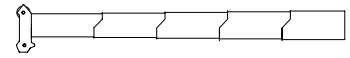

Boom Mode "Std"

Load Radius (Ft)	40 Ft.			50 Ft.		
	∠°	360°	Front	∠°	360°	Front
10	68.0	200,000	200,000	72.5	52,000	52,000
12	64.5	182,500	183,100	70.0	52,000	52,000
15	59.5	158,300	158,800	66.5	52,000	52,000
20	50.0	122,200	122,200	59.5	52,000	52,000
25	39.0	94,900	94,900	52.5	52,000	52,000
30	21.5	76,600	76,600	44.0	52,000	52,000
35				34.0	52,000	52,000
40				19.0	49,000	49,600
45						
50						
55						
60						
Min.Bm. Ang./Cap.	0 (31.5)	50,700	50,700	0 (41.5)	34,200	34,200
Load Radius (Ft)	60 Ft.			70 Ft.		
	∠°	360°	Front	∠°	360°	Front
10	75.5	52,000	52,000	78.0	52,000	52,000
12	73.5	52,000	52,000	76.0	52,000	52,000
15	70.5	52,000	52,000	73.5	52,000	52,000
20	65.5	52,000	52,000	69.5	52,000	52,000
25	60.0	52,000	52,000	65.0	52,000	52,000
30	54.0	52,000	52,000	60.5	52,000	52,000
35	47.5	52,000	52,000	55.5	52,000	52,000
40	40.0	49,600	50,200	50.0	49,900	50,500
45	31.0	40,000	40,600	43.5	40,300	40,800
50	17.0	33,000	33,400	37.0	33,400	33,900
55				28.5	28,100	28,500
60				15.5	23,800	24,200
Min.Bm. Ang./Cap.	0 (51.5)	24,700	24,700	0 (61.5)	18,900	18,900
Load Radius (Ft)	80 Ft.			90 Ft.		
	∠°	360°	Front	∠°	360°	Front
12	78.0	52,500	52,500			
15	76.0	52,500	52,500	78.0	53,500	53,500
20	72.5	52,500	52,500	75.0	53,500	53,500
25	68.5	52,500	52,500	71.5	53,500	53,500
30	65.0	52,500	52,500	68.5	53,500	53,500
35	61.0	52,500	52,500	65.0	53,500	53,500
40	56.5	50,000	50,600	61.0	50,200	50,800
45	51.5	40,500	41,000	57.0	40,600	41,100
50	46.5	33,600	34,000	53.0	33,700	34,200
55	41.0	28,300	28,700	48.5	28,400	28,800
60	34.5	24,100	24,400	44.0	24,200	24,600
65	26.5	20,700	21,000	38.5	20,800	21,100
70	14.5	17,900	18,100	32.5	18,000	18,300
75				25.0	15,700	16,000
80				13.5	13,700	14,000
85						
90						
95						
100						
Min.Bm. Ang./Cap.	0 (71.5)	14,600	14,600	0 (81.5)	11,500	11,500

Load Radius (Ft)	100 Ft.			110 Ft.		
	∠°	360°	Front	∠°	360°	Front
12						
15	79.5	54,000	54,000			
20	77.0	54,000	54,000	78.5	56,000	56,000
25	74.0	54,000	54,000	76.5	56,000	56,000
30	71.5	54,000	54,000	73.5	53,500	53,500
35	68.0	54,000	54,000	70.5	47,400	47,400
40	65.0	48,900	48,900	68.0	42,400	42,400
45	61.5	40,700	41,200	65.0	38,100	38,100
50	58.0	33,800	34,200	62.0	33,900	34,300
55	54.0	28,500	28,900	58.5	28,500	28,900
60	50.0	24,300	24,600	55.0	24,300	24,700
65	46.0	20,900	21,200	51.5	21,000	21,300
70	41.5	18,100	18,400	48.0	18,200	18,500
75	36.5	15,900	16,200	44.0	16,000	16,200
80	31.0	13,900	14,100	40.0	14,000	14,200
85	24.0	12,100	12,400	35.0	12,300	12,500
90	13.0	10,600	10,800	29.5	10,700	11,000
95				23.0	9,400	9,600
100				12.5	8,200	8,400
Min.Bm. Ang./Cap.	0 (91.5)	9,100	9,100	0 (101.5)	7,200	7,200
Load Radius (Ft)	120 Ft.			130 Ft.		
	∠°	360°	Front	∠°	360°	Front
25	78.0	53,200	53,200			
30	75.5	46,700	46,700	77.0	46,100	46,100
35	73.0	41,400	41,400	75.0	40,800	40,800
40	70.0	37,000	37,000	72.5	36,400	36,400
45	67.5	33,300	33,300	70.0	32,800	32,800
50	65.0	30,100	30,100	67.5	29,600	29,600
55	62.0	27,300	27,300	65.0	26,900	26,900
60	59.0	24,400	24,700	62.5	24,400	24,500
65	56.0	21,000	21,300	60.0	21,000	21,300
70	53.0	18,200	18,500	57.0	18,200	18,500
75	49.5	16,000	16,300	54.0	16,100	16,300
80	46.0	14,000	14,300	51.0	14,100	14,300
85	42.5	12,300	12,500	48.0	12,300	12,600
90	38.5	10,800	11,000	44.5	10,800	11,100
95	34.0	9,500	9,700	41.0	9,500	9,700
100	28.5	8,300	8,500	37.0	8,400	8,600
105	22.5	7,300	7,500	33.0	7,300	7,500
110	12.5	6,300	6,500	28.0	6,400	6,600
115				21.5	5,600	5,700
120				12.0	4,800	5,000
125						
130						
135						
140						
Min.Bm. Ang./Cap.	0 (111.5)	5,700	5,700	0 (121.5)	4,500	4,500

## Rated Lifting Capacities In Pounds

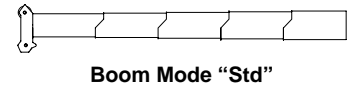
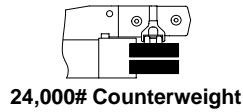
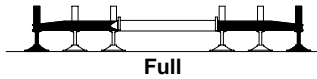

Load Radius (Ft)	140 Ft.			150 Ft.		
	$\angle$ °	360°	Front	$\angle$ °	360°	Front
25						
30	78.0	32,000	32,000	79.0	30,000	30,000
35	76.5	32,000	32,000	77.5	30,000	30,000
40	74.5	32,000	32,000	75.5	30,000	30,000
45	72.0	31,500	31,500	74.0	30,000	30,000
50	70.0	28,500	28,500	72.0	27,500	27,500
55	67.5	25,900	25,900	70.0	25,000	25,000
60	65.5	23,600	23,600	68.0	22,700	22,700
65	63.0	21,000	21,300	65.5	20,800	20,800
70	60.5	18,200	18,500	63.0	18,200	18,500
75	57.5	16,100	16,300	61.0	16,100	16,400
80	55.0	14,100	14,300	58.5	14,100	14,300
85	52.0	12,400	12,600	56.0	12,400	12,600
90	49.5	10,900	11,100	53.5	10,900	11,100
95	46.5	9,600	9,800	50.5	9,600	9,800
100	43.0	8,400	8,600	48.0	8,400	8,600
105	39.5	7,400	7,500	45.0	7,400	7,600
110	36.0	6,400	6,600	42.0	6,500	6,600
115	32.0	5,600	5,800	38.5	5,600	5,800
120	27.0	4,800	5,000	35.0	4,900	5,000
125	21.0	4,100	4,300	31.0	4,200	4,300
130	12.0	3,500	3,700	26.5	3,500	3,700
135				20.5	3,000	3,100
140				12.0	2,400	2,600
<b>Min.Bm. Ang./Cap.</b>	0 (131.5)	3,400	3,500	0 (141.5)	2,300	2,400

( ) Reference Radius For Minimum Boom Angle Capacities (Shown In Parenthesis) Are In Feet.

$\angle$ ° Loaded Boom Angle In Degrees.

**Rated Lifting Capacities  
In Pounds**

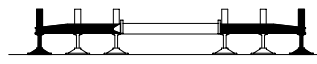

Full

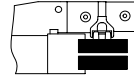

24,000# Counterweight

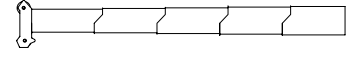

Boom Mode "Std"

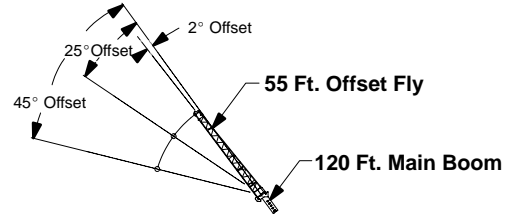
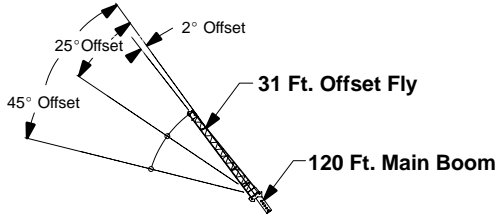

Load Radius (Ft.)	2° Offset		25° Offset		45° Offset	
	$\Delta^\circ$	360°	$\Delta^\circ$	360°	$\Delta^\circ$	360°
30	78.5	28,100				
35	76.5	26,700				
40	75.0	25,400	78.5	16,900		
45	73.0	24,200	77.0	16,400		
50	71.0	23,100	75.0	16,000	78.0	13,600
55	69.0	20,300	73.0	15,500	76.0	13,400
60	67.0	19,600	71.0	15,200	74.0	13,300
65	65.0	18,900	69.0	14,800	72.0	13,100
70	63.0	18,200	67.0	14,500	69.5	13,000
75	60.5	17,100	64.5	14,200	67.5	12,800
80	58.0	15,300	62.5	13,900	65.0	12,700
85	55.5	13,500	60.0	13,700	62.5	12,500
90	53.0	12,000	58.0	13,100	60.0	12,400
95	50.5	10,700	55.0	11,600	57.5	12,100
100	48.0	9,500	52.0	10,300	54.5	10,800
105	45.0	8,500	49.5	9,200	51.5	9,500
110	42.0	7,500	46.0	8,200	48.0	8,400
115	38.5	6,700	43.0	7,200	44.5	7,400
120	35.0	5,900	39.0	6,400		
125	31.5	5,200	35.0	5,600		
130	27.0	4,600	30.5	4,900		
135	21.5	4,000	25.0	4,200		
140	14.0	3,500				
Min.Bm. Ang./Cap	0	2,200	0	2,400	0	2,600

Load Radius (Ft.)	2° Offset		25° Offset		45° Offset	
	$\Delta^\circ$	360°	$\Delta^\circ$	360°	$\Delta^\circ$	360°
35	78.5	14,200				
40	77.0	13,700				
45	75.5	13,200				
50	74.0	12,800				
55	72.5	12,300	79.0	9,500		
60	71.0	11,900	77.5	9,200		
65	69.0	11,500	76.0	9,000		
70	67.5	11,100	74.0	8,700	79.0	7,000
75	65.5	10,800	72.5	8,400	77.0	6,900
80	64.0	10,400	70.5	8,200	75.0	6,700
85	62.0	10,100	68.5	7,900	73.0	6,600
90	60.5	9,800	67.0	7,700	71.0	6,500
95	58.5	9,500	65.0	7,500	69.0	6,400
100	56.5	9,300	63.0	7,300	67.0	6,300
105	54.5	9,000	61.0	7,100	64.5	6,200
110	52.5	8,500	58.5	6,900	62.5	6,200
115	50.0	7,700	56.5	6,800	60.0	6,100
120	47.5	6,900	54.0	6,600	57.5	6,100
125	45.0	6,200	51.5	6,500	54.5	6,000
130	42.5	5,500	49.0	6,400	52.0	6,000
135	39.5	4,900	46.0	5,700	48.5	6,000
140	36.5	4,400	43.0	5,000	45.0	5,200
145	33.5	3,900	39.5	4,400		
150	30.0	3,400	35.5	3,900		
155	26.0	3,000	31.0	3,300		
160	21.0	2,600	25.0	2,800		
165	13.0	2,200				
Min.Bm. Ang./Cap	0	1,100	0	1,200	0	1,500

$\Delta^\circ$  Loaded Boom Angle In Degrees.

This capacity based on maximum obtainable boom angle.

## Rated Lifting Capacities In Pounds

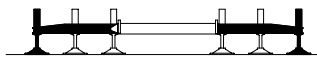

Full

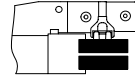

24,000# Counterweight

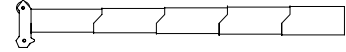

Boom Mode "Std"

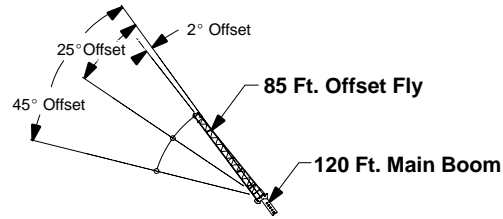
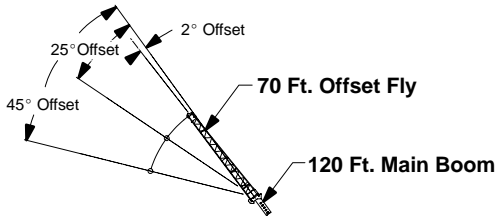

Load Radius (Ft.)	2° Offset		25° Offset		45° Offset	
	$\angle^\circ$	360°	$\angle^\circ$	360°	$\angle^\circ$	360°
40	78.5	11,600				
45	77.5	11,100				
50	76.0	10,600				
55	74.5	10,100				
60	73.0	9,600				
65	71.5	9,200	79.5	6,400		
70	70.0	8,800	77.5	6,100		
75	68.5	8,400	76.0	5,900		
80	66.5	8,100	74.5	5,700		
85	65.0	7,700	73.0	5,500	78.5	4,500
90	63.5	7,300	71.0	5,400	77.0	4,400
95	62.0	7,000	69.5	5,200	75.0	4,300
100	60.0	6,700	67.5	5,100	73.0	4,300
105	58.5	6,400	66.0	4,900	71.0	4,200
110	56.5	6,200	64.0	4,800	69.5	4,100
115	54.5	5,900	62.0	4,700	67.0	4,100
120	52.5	5,700	60.5	4,600	65.0	4,000
125	50.5	5,500	58.0	4,500	63.0	4,000
130	48.5	5,300	56.0	4,400	60.5	4,000
135	46.5	5,100	54.0	4,300	58.0	4,000
140	44.0	4,600	51.5	4,200	55.5	4,000
145	41.5	4,100	49.0	4,100	52.5	4,000
150	39.0	3,600	46.5	4,100	49.5	4,000
155	36.0	3,200	43.5	3,900	46.0	4,000
160	33.0	2,800	40.0	3,400		
165	30.0	2,400	36.5	2,900		
170	26.0	2,000	32.0	2,400		
175	21.5	1,700	26.0	1,900		
180	14.0	1,400				
Min.Bm. Ang./Cap	0	200	0	400	0	700

Load Radius (Ft.)	2° Offset		25° Offset		45° Offset	
	$\angle^\circ$	360°	$\angle^\circ$	360°	$\angle^\circ$	360°
45	78.5	8,300				
50	77.0	7,800				
55	76.0	7,400				
60	74.5	7,000				
65	73.0	6,600				
70	71.5	6,200				
75	70.5	5,800	79.5	3,800		
80	69.0	5,500	78.0	3,700		
85	67.5	5,200	76.5	3,500		
90	66.0	5,000	75.0	3,400		
95	64.5	4,700	73.5	3,300		
100	63.0	4,500	72.0	3,100	78.5	2,500
105	61.5	4,300	70.5	3,000	77.0	2,400
110	60.0	4,100	68.5	2,900	75.0	2,400
115	58.0	3,900	67.0	2,800	73.5	2,300
120	56.5	3,700	65.5	2,800	71.5	2,300
125	55.0	3,500	63.5	2,700	69.5	2,300
130	53.0	3,400	62.0	2,600	67.5	2,200
135	51.0	3,300	60.0	2,500	65.5	2,200
140	49.5	3,100	58.0	2,500	63.5	2,200
145	47.5	3,000	56.0	2,400	61.0	2,200
150	45.5	2,900	54.0	2,400	59.0	2,200
155	43.0	2,800	51.5	2,300	56.0	2,200
160	41.0	2,700	49.5	2,300	53.5	2,200
165	38.5	2,500	47.0	2,300	50.0	2,200
170	36.0	2,200	44.0	2,200	46.5	2,200
175	33.0	1,800	41.0	2,200		
180	30.0	1,500	37.5	2,000		
185	26.5	1,200	33.0	1,600		



### WARNING

Do Not Lower 85 Ft. Offset Fly In Working Position Below 25.5° Main Boom Angle Unless Main Boom Length Is 119 Ft. Or Less, Since Loss Of Stability Will Occur Causing A Tipping Condition.

$\angle^\circ$  Loaded Boom Angle In Degrees.

This capacity based on maximum obtainable boom angle.

**Rated Lifting Capacities  
In Pounds**

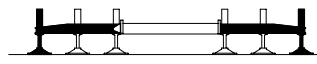

Full

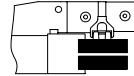

24,000# Counterweight

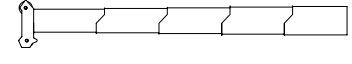

Boom Mode "Std"

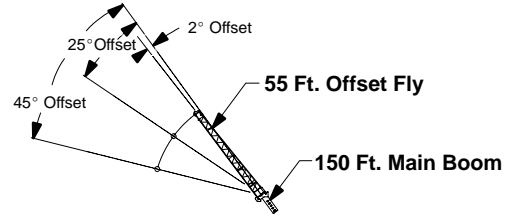
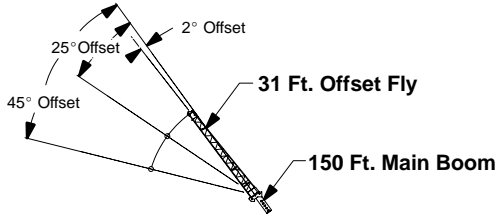

Load Radius (Ft.)	2° Offset		25° Offset		45° Offset	
	$\Delta^\circ$	360°	$\Delta^\circ$	360°	$\Delta^\circ$	360°
35	79.5	15,000				
40	78.0	15,000				
45	76.5	15,000				
50	75.5	15,000	79.0	14,700		
55	74.0	15,000	77.5	14,500		
60	72.5	15,000	76.0	14,200	78.5	12,700
65	71.0	15,000	74.5	14,000	77.0	12,500
70	69.5	15,000	73.0	13,800	75.5	12,400
75	68.0	15,000	71.5	13,600	73.5	12,300
80	66.0	14,500	70.0	13,400	72.0	12,200
85	64.0	13,100	68.0	13,200	70.5	12,100
90	62.0	11,600	66.5	12,800	68.5	12,000
95	60.0	10,200	64.0	11,300	66.5	11,900
100	58.0	9,100	62.0	10,100	64.5	10,700
105	56.0	8,000	60.0	8,900	62.0	9,500
110	54.0	7,100	57.5	7,900	60.0	8,400
115	51.5	6,200	55.5	7,000	57.5	7,400
120	49.0	5,500	53.0	6,200	55.0	6,500
125	47.0	4,800	50.5	5,400	52.5	5,700
130	44.5	4,100	48.0	4,700	49.5	4,900
135	42.0	3,600	45.5	4,100	46.5	4,300
140	39.0	3,000	42.5	3,500		
145	36.0	2,500	39.5	2,900		
150	33.0	2,100	36.5	2,400		
155	29.5	1,700	32.5	1,900		
160	25.5	1,300	28.5	1,500		



**WARNING**

Do Not Lower 31 Ft. Offset Fly In Working Position Below 21.5° Main Boom Angle Unless Main Boom Length Is 144 Ft. Or Less, Since Loss Of Stability Will Occur Causing A Tipping Condition.

Load Radius (Ft.)	2° Offset		25° Offset		45° Offset	
	$\Delta^\circ$	360°	$\Delta^\circ$	360°	$\Delta^\circ$	360°
45	78.5	10,100				
50	77.5	10,100				
55	76.0	10,100				
60	75.0	10,100				
65	73.5	10,000	79.5	8,200		
70	72.5	9,800	78.0	8,100		
75	71.0	9,600	76.5	7,900		
80	70.0	9,500	75.5	7,800	79.5	6,600
85	68.5	9,300	74.0	7,700	78.0	6,500
90	67.0	9,100	72.5	7,600	76.5	6,400
95	65.5	8,900	71.0	7,400	74.5	6,300
100	64.0	8,800	69.5	7,200	73.0	6,200
105	62.5	8,600	68.0	7,100	71.5	6,100
110	61.0	7,900	66.5	6,900	70.0	6,100
115	59.0	7,000	65.0	6,800	68.0	6,000
120	57.0	6,200	63.0	6,700	66.5	5,900
125	55.0	5,500	61.5	6,500	64.5	5,900
130	53.5	4,900	59.5	6,000	62.5	5,900
135	51.5	4,300	57.5	5,300	60.5	5,900
140	49.0	3,700	55.0	4,700	58.5	5,200
145	47.0	3,200	53.0	4,100	56.0	4,500
150	45.0	2,800	50.5	3,500	53.5	3,900
155	42.5	2,300	48.0	3,000	50.5	3,300
160	40.5	1,900	45.5	2,600	47.5	2,800
165	38.0	1,600	43.0	2,100	44.5	2,300
170			40.0	1,700		
175			37.0	1,300		



**WARNING**

Do Not Lower 55 Ft. Offset Fly In Working Position Below 35° Main Boom Angle Unless Main Boom Length Is 135 Ft. Or Less, Since Loss Of Stability Will Occur Causing A Tipping Condition.



Loaded Boom Angle In Degrees.

This capacity based on maximum obtainable boom angle.

## Rated Lifting Capacities In Pounds

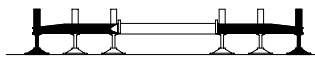

Full

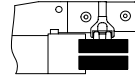

24,000# Counterweight

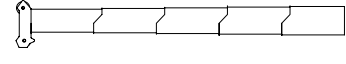

Boom Mode "Std"

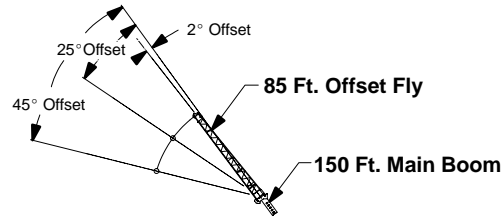
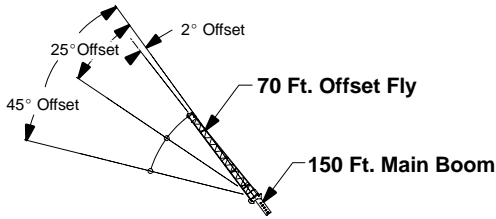

Load Radius (Ft.)	2° Offset		25° Offset		45° Offset	
	$\Delta^\circ$	360°	$\Delta^\circ$	360°	$\Delta^\circ$	360°
45	80.0*	9,300				
50	79.0	9,100				
55	78.0	8,900				
60	76.5	8,600				
65	75.5	8,400				
70	74.5	8,100				
75	73.0	7,900				
80	72.0	7,700	78.5	5,500		
85	70.5	7,400	77.0	5,400		
90	69.5	7,200	76.0	5,200		
95	68.0	6,900	74.5	5,100	79.5	4,200
100	66.5	6,700	73.0	5,000	78.0	4,200
105	65.5	6,500	71.5	4,900	76.5	4,100
110	64.0	6,300	70.5	4,700	75.0	4,000
115	62.5	6,100	69.0	4,600	73.5	4,000
120	61.0	5,900	67.5	4,600	72.0	4,000
125	59.5	5,700	66.0	4,500	70.0	3,900
130	57.5	5,100	64.5	4,400	68.5	3,900
135	56.0	4,500	63.0	4,300	67.0	3,900
140	54.0	3,900	61.0	4,200	65.0	3,800
145	52.5	3,400	59.5	4,200	63.5	3,800
150	50.5	2,900	57.5	4,000	61.5	3,800
155	48.5	2,500	55.5	3,500	59.5	3,800
160	46.5	2,100	53.5	3,000	57.0	3,500
165	44.5	1,700	51.0	2,500	54.5	2,900
170			49.0	2,100	51.5	2,400
175			46.5	1,700	49.0	1,900
180			44.0	1,300	46.0	1,500



### WARNING

Do Not Lower 70 Ft. Offset Fly In Working Position Below 42.5° Main Boom Angle Unless Main Boom Length Is 127 Ft. Or Less, Since Loss Of Stability Will Occur Causing A Tipping Condition.

Load Radius (Ft.)	2° Offset		25° Offset		45° Offset	
	$\Delta^\circ$	360°	$\Delta^\circ$	360°	$\Delta^\circ$	360°
50	80.0*	6,800				
55	79.0	6,500				
60	78.0	6,300				
65	76.5	6,000				
70	75.5	5,800				
75	74.5	5,500				
80	73.5	5,300				
85	72.0	5,100				
90	71.0	4,900	78.5	3,300		
95	70.0	4,700	77.5	3,200		
100	68.5	4,500	76.5	3,100		
105	67.5	4,300	75.0	3,000		
110	66.0	4,100	74.0	2,900	79.5	2,300
115	65.0	4,000	72.5	2,800	78.0	2,300
120	63.5	3,800	71.0	2,700	77.0	2,200
125	62.0	3,700	70.0	2,700	75.5	2,200
130	61.0	3,500	68.5	2,600	74.0	2,200
135	59.5	3,400	67.0	2,500	72.5	2,100
140	58.0	3,300	65.5	2,500	71.0	2,100
145	56.5	3,200	64.0	2,400	69.0	2,100
150	55.0	3,000	62.5	2,400	67.5	2,100
155	53.5	2,600	61.0	2,300	66.0	2,100
160	51.5	2,200	59.5	2,300	64.0	2,100
165	50.0	1,800	58.0	2,200	62.0	2,100
170			56.0	2,200	60.0	2,100
175			54.0	1,900	58.0	2,100
180			52.0	1,600	55.5	1,900
185			50.0	1,300	53.0	1,500
190			50.5	1,200		



### WARNING

Do Not Lower 85 Ft. Offset Fly In Working Position Below 48.5° Main Boom Angle Unless Main Boom Length Is 119 Ft. Or Less, Since Loss Of Stability Will Occur Causing A Tipping Condition.



Loaded Boom Angle In Degrees.

This capacity based on maximum obtainable boom angle.

**Rated Lifting Capacities In Pounds Stationary – Rear Between Tire Tracks**

With Outrigger Boxes



On Tires—Rear

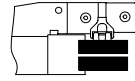

24,000# Counterweight

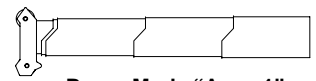

Boom Mode “Amax1”

Load Radius (Ft)	40 Ft.		50 Ft.	
	∠°	Rear	∠°	Rear
10	67.5	92,000		
12	64.5	73,200	70.0	61,800
15	59.5	62,300	66.5	61,800
20	50.0	49,500	59.5	49,100
25	38.5	37,600	52.5	37,200
30	21.5	27,100	44.0	26,800
35			34.0	20,000
40			18.5	15,200
45				
50				
55				
60				
Min.Bm.	0	24,700	0	13,900
Ang./Cap.	(31.5)		(41.5)	
Load Radius (Ft)	60 Ft.		70 Ft.	
	∠°	Rear	∠°	Rear
10				
12				
15	70.5	36,800		
20	65.5	36,800	69.5	26,200
25	60.0	36,800	65.0	26,200
30	54.0	26,600	60.0	26,200
35	47.0	19,700	55.0	19,600
40	40.0	15,000	49.5	14,900
45	30.5	11,500	43.5	11,300
50	16.5	8,700	36.5	8,600
55			28.0	6,400
60			15.5	4,600
Min.Bm.	0	8,000	0	4,100
Ang./Cap.	(51.5)		(61.5)	

Load Radius (Ft)	80 Ft.		90 Ft.		95 Ft.	
	∠°	Rear	∠°	Rear	∠°	Rear
30	64.5	25,900	68.0	19,100	69.5	14,500
35	60.0	19,300	64.0	19,100	66.0	14,500
40	56.0	14,700	60.5	14,500	62.5	14,500
45	51.0	11,200	56.5	11,100	58.5	11,000
50	46.0	8,500	52.5	8,400	55.0	8,300
55	40.5	6,300	48.0	6,200	51.0	6,200
60	34.0	4,600	43.5	4,500	47.0	4,400
65	26.5	3,100	38.0	3,000	42.0	3,000
MinBm	19.5		35.0		39.5	
Ang./Cap	(68.3)		(67.6)		(67.5)	

( ) Reference Radius For Minimum Boom Angle Capacities (Shown In Parenthesis) Are In Feet.

**Rated Lifting Capacities In Pounds Stationary – Rear Between Tire Tracks**

**With Outrigger Boxes**  **On Tires–Rear**

 **24,000# Counterweight**

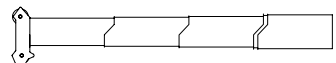
 **Boom Mode “Amax2”**

Load Radius (Ft)	40 Ft.		50 Ft.	
	∠°	Rear	∠°	Rear
10	67.5	92,000		
12	64.5	73,200	70.0	52,000
15	59.5	62,300	66.5	52,000
20	50.0	49,500	59.5	50,700
25	38.5	37,600	52.5	39,400
30	21.5	27,100	44.0	28,800
35			34.0	21,800
40			18.5	17,000
45				
50				
55				
60				
Min.Bm. Ang./Cap.	0 (31.5)	24,700	0 (41.5)	15,800
Load Radius (Ft)	60 Ft.		70 Ft.	
	∠°	Rear	∠°	Rear
10				
12				
15	70.5	40,300		
20	65.5	40,300	69.5	35,000
25	59.5	40,300	64.5	35,000
30	53.5	29,800	60.0	30,300
35	47.0	22,800	55.0	23,400
40	39.5	17,900	49.5	18,500
45	30.5	14,300	43.5	14,900
50	16.5	11,500	36.5	12,100
55			28.0	9,900
60			15.0	8,100
Min.Bm. Ang./Cap.	0 (51.5)	10,800	0 (61.5)	7,600

Load Radius (Ft)	80 Ft.		90 Ft.		100 Ft.	
	∠°	Rear	∠°	Rear	∠°	Rear
30	64.5	30,700	67.5	24,100	70.5	19,400
35	60.0	23,800	64.0	24,100	67.0	19,400
40	55.5	19,000	60.5	19,200	64.0	19,400
45	51.0	15,400	56.5	15,700	60.5	15,900
50	46.0	12,600	52.5	12,900	57.0	13,200
55	40.5	10,300	48.0	10,700	53.5	10,900
60	34.0	8,500	43.0	8,800	49.5	9,100
65	26.0	7,000	38.0	7,300	45.5	7,600
70	14.0	5,700	32.0	6,100	41.0	6,300
75			24.5	5,000	36.0	5,200
80			13.5	4,000	30.5	4,300
85					23.5	3,400
90					12.5	2,700
Min.Bm. Ang./Cap.	0 (71.5)	5,400	0 (81.5)	3,800	0 (91.5)	2,600

Load Radius (Ft)	110 Ft.		122.5 Ft.	
	∠°	Rear	∠°	Rear
35	70.0	16,100		
40	67.0	16,100	69.5	13,500
45	64.0	16,100	67.0	13,500
50	60.5	13,300	64.5	13,500
55	57.5	11,100	61.5	11,200
60	54.0	9,300	59.0	9,500
65	51.0	7,800	56.0	8,000
70	47.0	6,500	53.0	6,700
75	43.5	5,400	49.5	5,600
80	39.0	4,400	46.5	4,600
85	34.5	3,600	43.0	3,800
90	29.0	2,900	39.0	3,100
95	22.5	2,300	35.0	2,400
100	12.0	1,700	30.0	1,900
Min.Bm. Ang./Cap.	0 (101.5)	1,600	25.0 (104.4)	

( ) Reference Radius For Minimum Boom Angle Capacities (Shown In Parenthesis) Are In Feet.



**Rated Lifting Capacities In Pounds Stationary – Rear Between Tire Tracks**

With Outrigger Boxes



On Tires – Rear

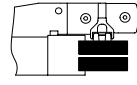

24,000# Counterweight

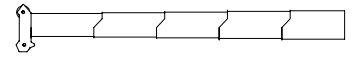

Boom Mode “Std”

Load Radius (Ft)	40 Ft.		50 Ft.	
	∠°	Rear	∠°	Rear
10	67.5	92,000		
12	64.5	73,200	70.0	52,000
15	59.5	62,300	66.5	52,000
20	50.0	49,500	59.5	50,200
25	38.5	37,600	52.5	38,600
30	21.5	27,100	44.0	28,100
35			34.0	21,200
40			18.5	16,400
45				
50				
55				
60				
Min.Bm. Ang./Cap.	0 (31.5)	24,700	0 (41.5)	15,100
Load Radius (Ft)	60 Ft.		70 Ft.	
	∠°	Rear	∠°	Rear
10				
12				
15	70.5	39,100		
20	65.5	39,100	69.5	28,900
25	59.5	39,100	64.5	28,900
30	53.5	28,700	60.0	28,900
35	47.0	21,700	55.0	22,100
40	39.5	17,000	49.5	17,300
45	30.5	13,300	43.5	13,700
50	16.5	10,500	36.5	10,900
55			28.0	8,700
60			15.0	6,900
Min.Bm. Ang./Cap.	0 (51.5)	9,800	0 (61.5)	6,400

Load Radius (Ft)	80 Ft.		90 Ft.		100 Ft.	
	∠°	Rear	∠°	Rear	∠°	Rear
30	64.5	29,100	67.5	22,300	70.5	17,600
35	60.0	22,300	64.0	22,300	67.0	17,600
40	55.5	17,500	60.0	17,600	64.0	17,600
45	51.0	14,000	56.5	14,200	60.5	14,200
50	46.0	11,200	52.0	11,400	57.0	11,500
55	40.5	9,000	48.0	9,200	53.5	9,300
60	34.0	7,200	43.0	7,300	49.5	7,500
65	26.0	5,700	38.0	5,900	45.5	6,000
70	14.0	4,400	32.0	4,600	41.0	4,700
75			24.5	3,500	36.0	3,700
80			13.0	2,600	30.5	2,700
85					23.5	1,900
Min.Bm. Ang./Cap	0 (71.5)	4,100	0 (81.5)	2,400	21.5 (86.1)	

Load Radius (Ft)	110 Ft.		120 Ft.	
	∠°	Rear	∠°	Rear
35	69.5	14,300		
40	66.5	14,300	69.0	11,600
45	63.5	14,300	66.5	11,600
50	60.5	11,600	63.5	11,600
55	57.5	9,400	61.0	9,400
60	54.0	7,600	58.0	7,700
65	50.5	6,100	55.0	6,200
70	47.0	4,800	52.0	4,900
75	43.0	3,800	48.5	3,800
80	39.0	2,800	45.0	2,900
85	34.5	2,000	41.5	2,100
Min.Bm. Ang./Cap.	32.5 (86.6)		39.0 (87.6)	

( ) Reference Radius For Minimum Boom Angle Capacities (Shown In Parenthesis) Are In Feet.

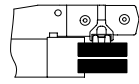
<b>Rated Lifting Capacities In Pounds. Between Tire Tracks Pick &amp; Carry – Creep</b>	<b>With Outrigger Boxes</b>  <b>On Tires–Creep</b>	 <b>24,000# Counterweight</b>	 <b>Boom Mode “Amax1”</b>
-----------------------------------------------------------------------------------------	-------------------------------------------------------------------------------------------------------------------------------------------	-------------------------------------------------------------------------------------------------------------------	-----------------------------------------------------------------------------------------------------------------

Load Radius (Ft)	40 Ft.		50 Ft.	
	∠°	Rear	∠°	Rear
10	67.5	90,600		
12	64.5	73,200	70.0	43,700
15	59.5	62,300	66.5	43,700
20	50.0	44,200	59.5	43,700
25	38.5	30,000	52.0	29,600
30	21.5	21,400	44.0	21,200
35			34.0	15,600
40			18.5	11,500
45				
50				
55				
60				
Min.Bm. Ang./Cap.	0 (31.5)	19,400	0 (41.5)	10,500
Load Radius (Ft)	60 Ft.		70 Ft.	
	∠°	Rear	∠°	Rear
10				
12				
15	70.5	29,300		
20	65.5	29,300	69.5	20,700
25	59.5	29,300	64.5	20,700
30	53.5	20,900	60.0	20,700
35	47.0	15,400	55.0	15,200
40	39.5	11,400	49.5	11,300
45	30.5	8,400	43.5	8,300
50	16.5	6,000	36.5	5,900
55			28.0	4,100
60			15.5	2,600
Min.Bm. Ang./Cap.	0 (51.5)	5,400	10.5 (60.9)	

Load Radius (Ft)	80 Ft.		90 Ft.		95 Ft.	
	∠°	Rear	∠°	Rear	∠°	Rear
30	64.5	20,400	67.5	14,900	69.0	10,900
35	60.0	15,100	64.0	14,900	65.5	10,900
40	55.5	11,100	60.5	11,000	62.0	10,900
45	51.0	8,200	56.5	8,000	58.5	8,000
50	46.0	5,800	52.5	5,700	55.0	5,700
55	40.5	4,000	48.0	3,900	51.0	3,900
60	34.0	2,500	43.5	2,400		
Min.Bm. Ang./Cap	33.0 (60.5)		42.5 (60.2)	0	46.5 (60.0)	0

( ) Reference Radius For Minimum Boom Angle Capacities (Shown In Parenthesis) Are In Feet.

**Rated Lifting Capacities In Pounds. Between Tire Tracks Pick & Carry – Creep**

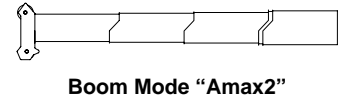
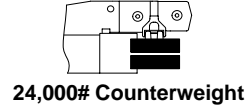
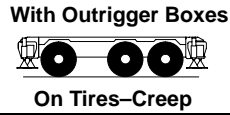

Load Radius (Ft)	40 Ft.		50 Ft.	
	∠°	Rear	∠°	Rear
10	67.5	90,600		
12	64.5	73,200	70.0	52,000
15	59.5	62,300	66.5	52,000
20	50.0	44,200	59.5	45,900
25	38.5	30,000	52.0	31,600
30	21.5	21,400	44.0	23,000
35			34.0	17,400
40			18.5	13,300
45				
50				
55				
60				
Min.Bm. Ang./Cap.	0 (31.5)	19,400	0 (41.5)	12,200
Load Radius (Ft)	60 Ft.		70 Ft.	
	∠°	Rear	∠°	Rear
10				
12				
15	70.5	32,600		
20	65.5	32,600	69.5	26,500
25	59.5	32,600	64.5	26,500
30	53.5	24,000	60.0	24,600
35	47.0	18,200	55.0	18,900
40	39.5	14,200	49.5	14,900
45	30.5	11,200	43.5	11,800
50	16.5	8,800	36.5	9,400
55			28.0	7,500
60			15.0	5,900
Min.Bm. Ang./Cap.	0 (51.5)	8,200	0 (61.5)	5,500

Load Radius (Ft)	80 Ft.		90 Ft.		100 Ft.	
	∠°	Rear	∠°	Rear	∠°	Rear
30	64.0	25,000	67.5	19,500	70.5	15,800
35	60.0	19,300	64.0	19,500	67.0	15,800
40	55.5	15,300	60.0	15,600	63.5	15,800
45	51.0	12,200	56.5	12,600	60.5	12,800
50	46.0	9,800	52.0	10,200	57.0	10,400
55	40.5	7,900	48.0	8,200	53.0	8,500
60	34.0	6,300	43.0	6,700	49.5	6,900
65	26.0	5,100	38.0	5,400	45.5	5,600
70	14.0	4,000	32.0	4,300	41.0	4,500
75			24.5	3,300	36.0	3,600
80			13.0	2,500	30.5	2,700
85					23.5	2,000
Min.Bm. Ang./Cap.	0 (71.5)	3,700	0 (81.5)	2,300	15.5 (89.0)	

Load Radius (Ft)	110 Ft.		122.5 Ft.	
	∠°	Rear	∠°	Rear
35	69.5	12,900		
40	66.5	12,900	69.5	10,700
45	63.5	12,900	67.0	10,700
50	60.5	10,600	64.0	10,700
55	57.5	8,700	61.5	8,800
60	54.0	7,100	58.5	7,300
65	50.5	5,800	55.5	6,000
70	47.0	4,700	52.5	4,900
75	43.0	3,700	49.5	3,900
80	39.0	2,900	46.0	3,100
85	34.5	2,200	42.5	2,400
90	29.0	1,600	39.0	1,800
Min.Bm. Ang./Cap.	28.0 (90.7)		36.5 (92.6)	

( ) Reference Radius For Minimum Boom Angle Capacities (Shown In Parenthesis) Are In Feet.

**Rated Lifting Capacities In Pounds. Between Tire Tracks Pick & Carry – Creep**

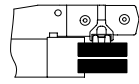
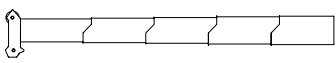
**With Outrigger Boxes**  **On Tires–Creep**  **24,000# Counterweight**  **Boom Mode “Std”**

Load Radius (Ft)	40 Ft.		50 Ft.	
	$\angle$ °	Rear	$\angle$ °	Rear
10	67.5	90,600		
12	64.5	73,200	70.0	52,000
15	59.5	62,300	66.5	52,000
20	50.0	44,200	59.5	45,100
25	38.5	30,000	52.0	30,900
30	21.5	21,400	44.0	22,400
35			34.0	16,800
40			18.5	12,700
45				
50				
55				
60				
Min.Bm. Ang./Cap.	0 (31.5)	19,400	0 (41.5)	11,600
Load Radius (Ft)	60 Ft.		70 Ft.	
	$\angle$ °	Rear	$\angle$ °	Rear
10				
12				
15	70.5	31,500		
20	65.5	31,500	69.5	23,300
25	59.5	31,500	64.5	23,300
30	53.5	22,900	60.0	23,300
35	47.0	17,300	54.5	17,600
40	39.5	13,300	49.5	13,600
45	30.5	10,200	43.5	10,600
50	16.5	7,800	36.5	8,200
55			28.0	6,300
60			15.0	4,800
Min.Bm. Ang./Cap.	0 (51.5)	7,200	0 (61.5)	4,400

Load Radius (Ft)	80 Ft.		90 Ft.		100 Ft.	
	$\angle$ °	Rear	$\angle$ °	Rear	$\angle$ °	Rear
30	64.0	23,400	67.5	17,900	70.0	14,100
35	60.0	17,800	64.0	17,900	67.0	14,100
40	55.5	13,900	60.0	14,000	63.5	14,100
45	51.0	10,800	56.0	11,000	60.5	11,100
50	46.0	8,500	52.0	8,600	57.0	8,800
55	40.5	6,600	48.0	6,800	53.0	6,900
60	34.0	5,000	43.0	5,200	49.5	5,300
65	26.0	3,700	38.0	3,900	45.0	4,100
70	14.0	2,700	32.0	2,800	41.0	3,000
75			24.5	1,900	36.0	2,000
Min.Bm. Ang./Cap.	0 (71.5)	2,400	23.5 (75.4)		34.5 (76.3)	

Load Radius (Ft)	110 Ft.		120 Ft.	
	$\angle$ °	Rear	$\angle$ °	Rear
35	69.5	11,200		
40	66.5	11,200	69.0	8,900
45	63.5	11,200	66.0	8,900
50	60.5	8,900	63.5	8,900
55	57.5	7,000	60.5	7,100
60	54.0	5,400	57.5	5,500
65	50.5	4,200	54.5	4,200
70	47.0	3,100	51.5	3,100
75	43.0	2,100	48.5	2,200
Min.Bm. Ang./Cap.	41.5 (76.8)		46.5 (77.3)	0

( ) Reference Radius For Minimum Boom Angle Capacities (Shown In Parenthesis) Are In Feet.

**Rated Lifting Capacities  
In Pounds.  
Pick & Carry – 2.5 mph**

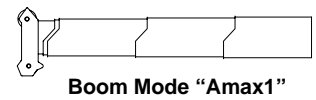
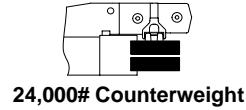
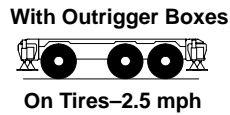

Load Radius (Ft)	40 Ft.		50 Ft.	
	∠ °	Rear	∠ °	Rear
10	67.5	88,300		
12	64.5	73,200	70.0	41,400
15	59.5	62,300	66.5	41,400
20	50.0	41,900	59.5	41,400
25	38.5	28,400	52.0	28,100
30	21.5	20,300	44.0	20,000
35			34.0	14,700
40			18.5	10,800
45				
50				
55				
60				
Min.Bm. Ang./Cap.	0 (31.5)	18,400	0 (41.5)	9,800
Load Radius (Ft)	60 Ft.		70 Ft.	
	∠ °	Rear	∠ °	Rear
10				
12				
15	70.5	27,800		
20	65.5	27,800	69.5	19,500
25	59.5	27,800	64.5	19,500
30	53.5	19,800	60.0	19,500
35	47.0	14,500	55.0	14,300
40	39.5	10,600	49.5	10,500
45	30.5	7,800	43.5	7,600
50	16.5	5,500	36.5	5,400
55			28.0	3,600
60			15.5	2,100
Min.Bm. Ang./Cap.	0 (51.5)	4,900	10.5 (60.9)	

Load Radius (Ft)	80 Ft.		90 Ft.		95 Ft.	
	∠ °	Rear	∠ °	Rear	∠ °	Rear
30	64.5	19,300	67.5	14,000	69.0	10,200
35	60.0	14,200	64.0	14,000	65.5	10,200
40	55.5	10,400	60.5	10,300	62.0	10,200
45	51.0	7,500	56.5	7,400	58.5	7,400
50	46.0	5,300	52.5	5,200	55.0	5,100
55	40.5	3,500	48.0	3,400	51.0	3,400
60	34.0	2,000	43.5	1,900		
Min.Bm. Ang./Cap	33.0 (60.5)		42.5 (60.2)		46.5 (60.0)	

( ) Reference Radius For Minimum Boom Angle Capacities (Shown In Parenthesis) Are In Feet.

<p><b>Rated Lifting Capacities In Pounds. Pick &amp; Carry – 2.5 mph</b></p>	<p><b>With Outrigger Boxes</b></p>  <p><b>On Tires–2.5 mph</b></p>	 <p><b>24,000# Counterweight</b></p>	 <p><b>Boom Mode “Amax2”</b></p>
--------------------------------------------------------------------------------------	-----------------------------------------------------------------------------------------------------------------------------------------------------	-----------------------------------------------------------------------------------------------------------------------	---------------------------------------------------------------------------------------------------------------------

Load Radius (Ft)	40 Ft.		50 Ft.	
	$\angle$ °	Rear	$\angle$ °	Rear
10	67.5	88,300		
12	64.5	73,200	70.0	52,000
15	59.5	62,300	66.5	52,000
20	50.0	41,900	59.5	43,600
25	38.5	28,400	52.0	30,000
30	21.5	20,300	44.0	21,800
35			34.0	16,400
40			18.5	12,500
45				
50				
55				
60				
Min.Bm. Ang./Cap.	0 (31.5)	18,400	0 (41.5)	11,500
Load Radius (Ft)	60 Ft.		70 Ft.	
	$\angle$ °	Rear	$\angle$ °	Rear
10				
12				
15	70.5	31,000		
20	65.5	31,000	69.5	25,000
25	59.5	31,000	64.5	25,000
30	53.5	22,800	60.0	23,400
35	47.0	17,400	55.0	17,900
40	39.5	13,500	49.5	14,100
45	30.5	10,500	43.5	11,100
50	16.5	8,200	36.5	8,800
55			28.0	7,000
60			15.0	5,500
Min.Bm. Ang./Cap.	0 (51.5)	7,600	0 (61.5)	5,100

Load Radius (Ft)	80 Ft.		90 Ft.		100 Ft.	
	$\angle$ °	Rear	$\angle$ °	Rear	$\angle$ °	Rear
30	64.0	23,800	67.5	18,600	70.0	15,000
35	60.0	18,400	64.0	18,600	67.0	15,000
40	55.5	14,500	60.0	14,900	63.5	15,000
45	51.0	11,600	56.5	11,900	60.5	12,100
50	46.0	9,200	52.0	9,600	57.0	9,800
55	40.5	7,400	48.0	7,700	53.0	8,000
60	34.0	5,900	43.0	6,200	49.5	6,400
65	26.0	4,600	38.0	4,900	45.5	5,200
70	14.0	3,600	32.0	3,900	41.0	4,100
75			24.5	3,000	36.0	3,200
80			13.0	2,200	30.5	2,400
85					23.5	1,700
Min.Bm. Ang./Cap.	0 (71.5)	3,300	0 (81.5)	2,000	15.5 (89.0)	
Load Radius (Ft)	110.0 Ft.		122.5 Ft.			
	$\angle$ °	Rear	$\angle$ °	Rear		
35	69.5	12,300				
40	66.5	12,300	69.5	10,200		
45	63.5	12,300	67.0	10,200		
50	60.5	10,000	64.0	10,200		
55	57.5	8,200	61.5	8,300		
60	54.0	6,600	58.5	6,800		
65	50.5	5,400	55.5	5,600		
70	47.0	4,300	52.5	4,500		
75	43.0	3,400	49.5	3,600		
80	39.0	2,600	46.0	2,800		
85	34.0	1,900	42.5	2,100		
90	29.0	1,300	39.0	1,500		
Min.Bm. Ang./Cap.	28.0 (90.7)		36.5 (92.6)			

( ) Reference Radius For Minimum Boom Angle Capacities (Shown In Parenthesis) Are In Feet.

**Rated Lifting Capacities  
In Pounds.  
Pick & Carry – 2.5 mph**

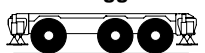
**With Outrigger Boxes**  
  
**On Tires–2.5 mph**

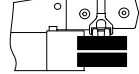
  
**24,000# Counterweight**

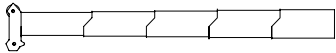

  
**Boom Mode “Std”**

Load Radius (Ft)	40 Ft.		50 Ft.	
	$\angle$ °	Rear		Rear
10	67.5	88,300		
12	64.5	73,200	70.0	52,000
15	59.5	62,300	66.5	52,000
20	50.0	41,900	59.5	42,800
25	38.5	28,400	52.0	29,400
30	21.5	20,300	44.0	21,200
35			34.0	15,800
40			18.5	11,900
45				
50				
55				
60				
Min.Bm.	0	18,400	0	10,900
Ang./Cap.	(31.5)		(41.5)	
Load Radius (Ft)	60 Ft.		70 Ft.	
	$\angle$ °	Rear	$\angle$ °	Rear
10				
12				
15	70.5	29,900		
20	65.5	29,900	69.0	22,100
25	59.5	29,900	64.5	22,100
30	53.5	21,800	60.0	22,100
35	47.0	16,400	54.5	16,800
40	39.5	12,500	49.5	12,900
45	30.5	9,600	43.5	9,900
50	16.5	7,300	36.5	7,600
55			28.0	5,800
60			15.0	4,300
Min.Bm.	0	6,700	0	3,900
Ang./Cap.	(51.5)		(61.5)	

Load Radius (Ft)	80 Ft.		90 Ft.		100 Ft.	
	$\angle$ °	Rear	$\angle$ °	Rear	$\angle$ °	Rear
30	64.0	22,200	67.5	22,300	70.0	22,400
35	60.0	17,000	64.0	17,100	67.0	17,200
40	55.5	13,100	60.0	13,300	63.5	13,400
45	51.0	10,200	56.0	10,400	60.5	10,500
50	46.0	7,900	52.0	8,100	57.0	8,200
55	40.5	6,100	48.0	6,200	53.0	6,400
60	34.0	4,600	43.0	4,800	49.5	4,900
65	26.0	3,300	38.0	3,500	45.0	3,600
70	14.0	2,300	32.0	2,500	41.0	2,600
75			24.5	1,600	36.0	1,700
Min.Bm.	0	2,000	23.5		34.5	
Ang./Cap.	(71.5)		(75.4)		(76.3)	

Load Radius (Ft)	110 Ft.		120 Ft.	
	$\angle$ °	Rear	$\angle$ °	Rear
35	69.5	17,200		
40	66.5	13,400	69.0	13,500
45	63.5	10,500	66.0	10,600
50	60.5	8,300	63.5	8,300
55	57.5	6,500	60.5	6,600
60	54.0	5,000	57.5	5,100
65	50.5	3,700	54.5	3,800
70	47.0	2,700	51.5	2,800
75	43.0	1,800	48.5	1,900
Min.Bm.	41.5		46.5	
Ang./Cap.	(76.8)		(77.3)	

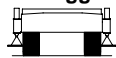
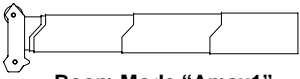
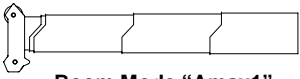
( ) Reference Radius For Minimum Boom Angle Capacities (Shown In Parenthesis) Are In Feet.

<b>Rated Lifting Capacities In Pounds. On Tires – Stationary – 360°</b>					<b>With Outrigger Boxes</b>					
					<b>On Tires–360°</b>		<b>24,000# Counterweight</b>		<b>Boom Mode “Amax1”</b>	
Load Radius (Ft)	40.Ft.		50 Ft.		Load Radius (Ft)	60 Ft.		70 Ft.		
	$\angle$	360°	$\angle$	360°		$\angle$	360°	$\angle$	360°	
25	38.5	19,700			25					
30	21.5	13,700	44.0	13,500	30					
35			34.0	9,400	35	47.0	9,200			
40			18.5	6,400	40	39.5	6,300			
45					45	30.5	4,000	43.5	3,900	
50					50	16.5	2,200	36.5	2,100	
Min.Bm.	0	12,300	0	5,600	Min.Bm.	0	1,700	32.5		
Ang./Cap.	(31.5)		(41.5)		Ang./Cap.	(51.5)		(52.4)		
 <b>WARNING</b> Do Not Raise Boom Above 47° Boom Angle. Loss Of Backward Stability Will Occur Causing a Tipping Condition.					 <b>WARNING</b> Do Not Raise Boom Above 47° Boom Angle. Loss Of Backward Stability Will Occur Causing a Tipping Condition.					

( ) Reference Radius For Minimum Boom Angle Capacities (Shown In Parenthesis) Are In Feet.



**Rated Lifting Capacities  
In Pounds. On Tires –  
Stationary – 360°**

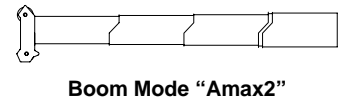
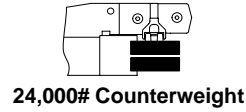

Load Radius (Ft)	40 Ft.		50 Ft.		60 Ft.	
	∠ °	360°	∠ °	360°	∠ °	360°
25	38.5	19,700				
30	21.5	13,700	44.0	15,200		
35			34.0	11,100	47.0	12,000
40			18.5	8,100	39.5	9,000
45					30.5	6,700
50					16.5	4,900
Min.Bm. Ang./ Cap.	0 (31.5)	12,300	0 (41.5)	7,300	0 (51.5)	4,400



**WARNING**

**Do Not Raise Boom Above 47° Boom Angle. Loss Of Backward Stability Will Occur Causing a Tipping Condition.**

Load Radius (Ft)	70 Ft.		80 Ft.	
	∠ °	360°	∠ °	360°
40				
45	43.5	7,300		
50	36.5	5,400	46.0	5,900
55	28.0	4,000	40.5	4,400
60	15.0	2,800	34.0	3,200
65			26.0	2,200
70			14.0	1,400
Min.Bm. Ang./Cap.	0 (61.5)	2,500	0 (71.5)	1,100



**WARNING**

**Do Not Raise Boom Above 47° Boom Angle. Loss Of Backward Stability Will Occur Causing a Tipping Condition.**

( ) Reference Radius For Minimum Boom Angle Capacities (Shown In Parenthesis) Are In Feet.

Rated Lifting Capacities In Pounds. On Tires – Stationary – 360°							With Outrigger Boxes On Tires–360°		24,000# Counterweight		Boom Mode “Std”					
Load Radius (Ft)	40 Ft.		50 Ft.		60 Ft.		Load Radius (Ft)	70 Ft.		80 Ft.		Load Radius (Ft)	70 Ft.		80 Ft.	
	∠°	360°	∠°	360°	∠°	360°		∠°	360°	∠°	360°		∠°	360°	∠°	360°
25	38.5	19,700					45	43.5	6,100							
30	21.5	13,700	44.0	14,600			50	36.5	4,300	46.0	4,600					
35			34.0	10,500	47.0	11,000	55	28.0	2,900	40.5	3,100					
40			18.5	7,500	39.5	8,100	60	15.0	1,700	34.0	1,900					
45					30.5	5,800	Min.Bm.									
50					16.5	4,000	Ang./Cap.	0	1,400	27.5						
Min.Bm.	0	12,300	0	6,700	0	3,500		(61.5)		(64.1)						
Ang./Cap	(31.5)		(41.5)		(51.5)		<p align="center"><b>⚠ WARNING</b></p> <p align="center"><b>Do Not Raise Boom Above 47° Boom Angle. Loss Of Backward Stability Will Occur Causing a Tipping Condition.</b></p>									

( ) Reference Radius For Minimum Boom Angle Capacities (Shown In Parenthesis) Are In Feet.

**This Page Intentionally Blank**

