

GCD25 Product Guide

ASME B30.5
Imperial 85%, Metric 85%



Features

- 22,7 t (25 USt) capacity
- 21,6 m (71 ft) four-section full-power boom
- 13,6 t (15 USt) deck carrying ability
- Tilt steering wheel
- Load sensing hydraulic piston pump
- Proportional hydraulic controls

GROVE GCD25

The new GCD25 is a 22 t (25 USt) capacity carrydeck crane, offering a four-section 21,6 m (71 ft) boom, four-wheel drive/four-wheel steer capability. It also has a four-position pivoting boom head for low head room clearance and out and down outriggers that can be setup in several modes depending on jobsite requirements.

Features

> Best-in-class reach

A 5,1 m (17 ft) swingaway extension added to the 21,6 m (71 ft) main boom provides an impressive 28,9 m (95 ft) tip height with a capacity of 2268 kg (5000 lb).

> Operator cab

Simple operator cab features hydraulic joystick controls, tilt steering wheel and easy-to-set up graphic RCL system. Also features 12 volt DC charging port, cup holder and comfortable suspension seat. Optional enclosed cab features split door design for additional comfort.

> Options

- Convenience package includes pintle hitches and light grilles
- Lighting package includes amber strobe light and boom-mounted work lights
- Below-deck winch
- Air-conditioning
- RCL with Work Area Definition system

> Customized Lift Solution Options

Standard options may not always meet the job requirements. Consult your local dealer for a Lift Solution quote for customized options such as:

- Non-marking tires
- Oil cooler
- Barge charts
- External light bar
- Spark arrestor

> Pivoting boom nose

Ideal for operating in confined spaces, the four-position mechanically offset (0°, 30°, 60° and 80°) pivoting boom nose lowers boom nose head height by 0,6 m (2 ft).

Negative pivoting of 15° and 30° allows boom extension offset capability. The offset increases ground clearance for transporting a large load through a low clearance entrance/exit.



GCD25 benefits

Tier 4 Final emissions kept simple

The aftertreatment system has been strategically placed behind the cab maintaining a clear right-hand space on the deck allowing long materials to be easily transported on the machine. Loads can be carried on the front deck, side deck, or hook. The diesel exhaust fluid (DEF) tank is easily accessed at the rear of the machine.



Convenient storage compartment

Built-in storage compartment to accommodate chains, tie downs, tools or down haul weight.

Easy to transport

Exceptional capacity for its operational footprint. This compact design offers the lightest overall GVW in its class to enhance transportability.



What you need, when you need it.

Get right to work with the right equipment — Manitowoc Finance gives you access to flexible, affordable financing you can use to seize profitable new opportunities as they arise.

Feel confident in your investment — rest easy with the assurance of the world's most advanced crane service and support network.

Table of contents

Dimensions.....	5
Working range - Imperial 85%.....	7
Load chart - Imperial 85%.....	8
Working range - Metric 85%.....	11
Load chart - Metric 85%.....	12
Transportation and lifting data.....	15
Load handling.....	16
Specifications.....	18
Symbols glossary.....	20

Dimensions and weights

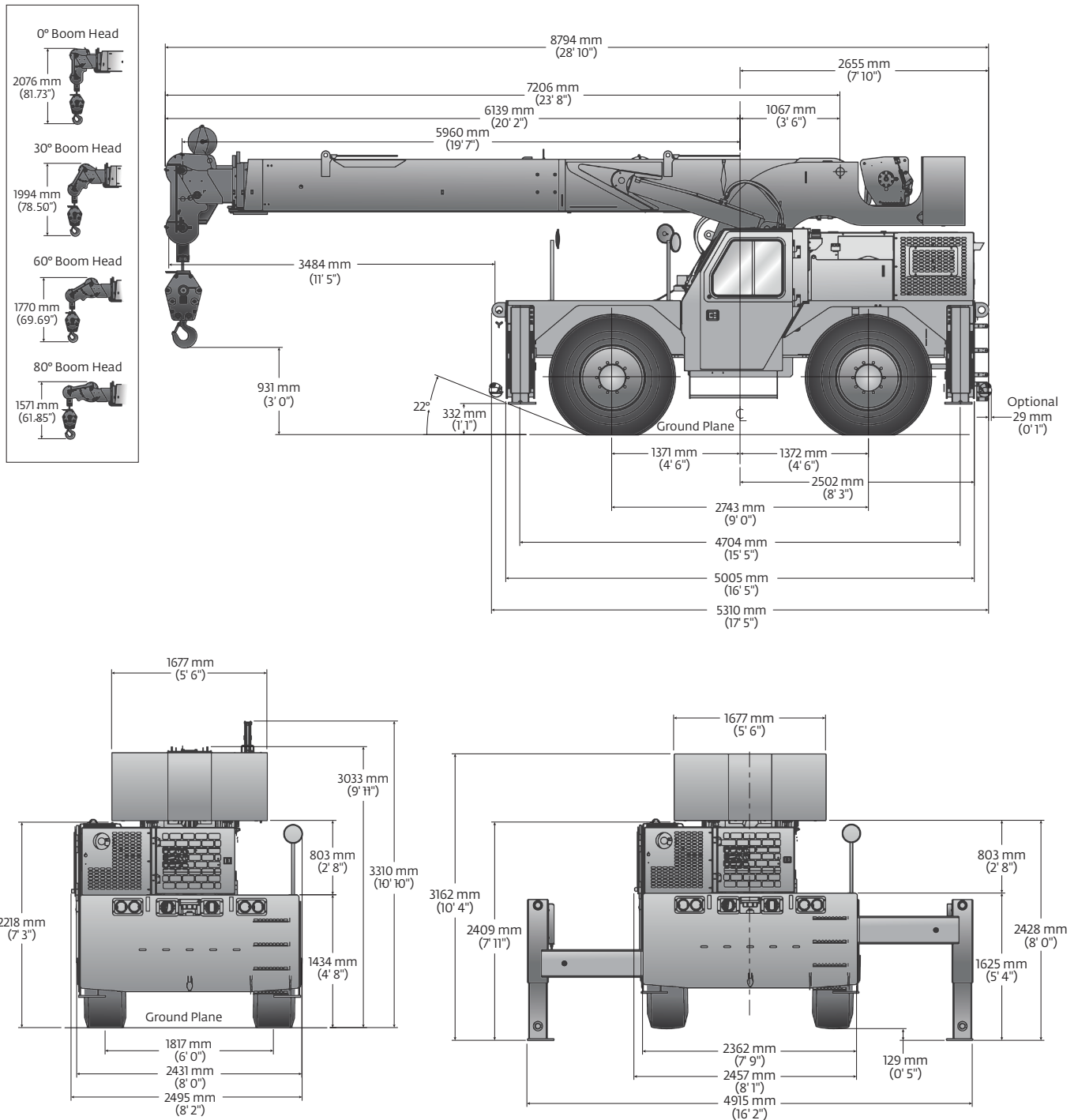

Dimensions

Dimensions										
Tire size	A	B	C	D	E	A	B	C	D	E
17.5 x 25	8593 mm (338.3 in)	6178 mm (243.2 in)	5556 mm (218.7 in)	5337 mm (210.1 in)	3813 mm (150.1 in)	7062 mm (278.0 in)	4828 mm (190.1 in)	4454 mm (175.4 in)	4109 mm (161.8 in)	2422 mm (95.3 in)
	Two-wheel steer (radius)					Four-wheel steer (radius)				

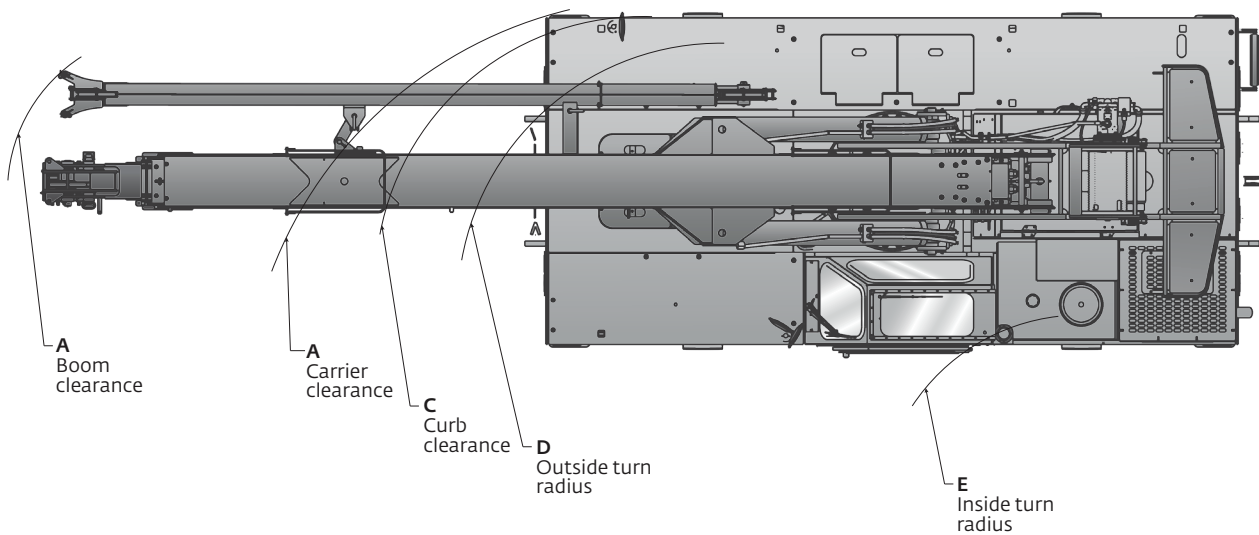

Weights						
	GVW		Front		Rear	
	kg	lb	kg	lb	kg	lb
Basic machine: including 21,6 m (71.0 ft) main boom, hoist with 119,0 m (390 ft) of wire rope, 22,6 t (25 USt) hook block, counterweight, Tier 4 engine, and driver.	20 623	45,465	10 115	22,299	10 508	23,166
Add: 5,1 m (17 ft) fixed swingaway extension and extension carrier brackets and downhaul weight.	255	563	458	1010	-203	-447
Crane weight	20 878	46,028	10 573	23,309	10 305	22,719
Basic machine: including 21,6 m (71.0 ft) main boom, main hoist with 119,0 m (390 ft) of wire rope, 22,6 t (25 USt) hook block, full counterweight, Tier 4 engine, and driver.	20 623	45,465	10 115	22,299	10 508	23,166
Add: Enclosed cab with heater and defroster.	106	233	47	104	59	129
Crane weight	20 729	45,698	10 162	22,402	10 567	23,296

Working range

Imperial 85%

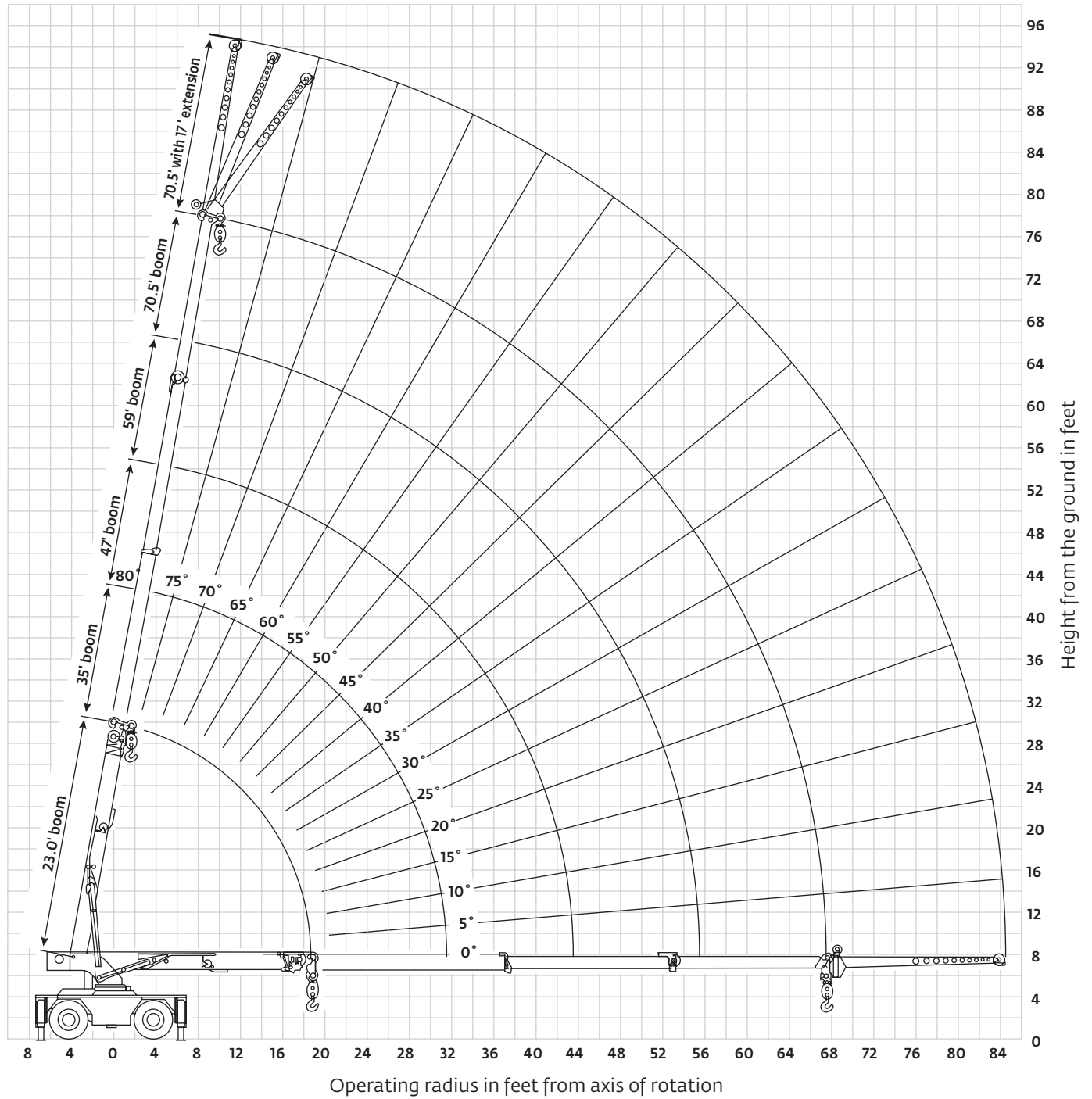

*THIS CHART IS ONLY A GUIDE AND SHOULD NOT BE USED TO OPERATE THE CRANE.
The individual crane's load chart, operating instructions and other instructional plates must be read and understood prior to operating the crane*

Load chart

Imperial 85%

23 ft - 70.5 ft 4700 lb 100% (360°) 0% (front/rear ± 15° defined arc)

pounds

ft	23	35	47	59	70.5
8.5	50,000 (64.5)	34,300 (73.5)	33,600 (78.5)	—	—
10	38,750 (60)	34,500 (71)	33,000 (76.5)	27,800 (80)	—
12	34,850 (54)	31,400 (67)	29,250 (74)	25,900 (78)	—
14	31,250 (47)	28,450 (63.5)	26,350 (71)	24,100 (76)	18,200 (79)
16	26,700 (39)	26,050 (59.5)	24,000 (68.5)	22,400 (74)	16,750 (77.5)
18	23,150 (29)	23,500 (55.5)	22,100 (66)	20,750 (72)	15,500 (75.5)
19.5	21,000 (0)	21,350 (52)	20,900 (63.5)	19,550 (70.5)	14,650 (74.5)
22	—	18,450 (46)	18,600 (60)	17,850 (67.5)	13,400 (72)
24	—	16,550 (41)	16,750 (57)	16,300 (65)	12,500 (70.5)
26	—	14,600 (36)	14,850 (54)	14,200 (63)	11,750 (68.5)
28	—	12,750 (29)	13,050 (51)	13,150 (60.5)	11,050 (67)
30	—	11,250 (20)	11,600 (47.5)	11,700 (58.5)	9800 (65.5)
31.5	—	10,300 (0)	10,650 (45)	10,750 (56.5)	9400 (64)
34	—	—	9350 (40)	9480 (53.5)	8850 (61.5)
36	—	—	8460 (36)	8590 (51)	8400 (60)
38	—	—	7680 (31)	7830 (48.5)	7940 (57)
40	—	—	7000 (25)	7150 (45.5)	7270 (55)
42	—	—	6400 (17.5)	6550 (42.5)	6680 (53)
43.5	—	—	6000 (0)	6000 (40.5)	6270 (51.5)
46	—	—	—	5440 (36)	5680 (48.5)
48	—	—	—	5040 (32.5)	5250 (46.5)
50	—	—	—	4680 (28)	4860 (44)
52	—	—	—	4350 (23)	4510 (41.5)
54	—	—	—	4040 (16)	4190 (38.5)
55.5	—	—	—	3820 (0)	3960 (36.5)
58	—	—	—	—	3620 (32.5)
60	—	—	—	—	3370 (29)
62	—	—	—	—	3130 (25)
64	—	—	—	—	2920 (20)
66	—	—	—	—	2720 (13)
67	—	—	—	—	2620 (0)

NOTE: () Boom angles are in degrees.

80088568

23 ft - 70.5 ft 4700 lb 0% 360°

pounds

ft	23	35	47	59	70.5
8.5	26,350 (63.5)	24,000 (73)	21,900 (78)	—	—
10	20,800 (59)	19,300 (70.5)	17,900 (76)	16,650 (79.5)	—
12	16,000 (52.5)	15,100 (67)	14,200 (73.5)	13,350 (77.5)	—
14	12,300 (45.5)	12,250 (63)	11,600 (71)	11,000 (75.5)	10,500 (79)
16	9850 (37)	10,150 (59.5)	9710 (68.5)	9280 (73.5)	8870 (77)
18	8070 (26)	8370 (55.5)	8230 (65.5)	7910 (71.5)	7590 (75.5)
19.5	7090 (0)	7300 (52)	7330 (63.5)	7060 (70)	6810 (74)
22	—	5900 (46.5)	6050 (60)	5900 (67.5)	5720 (72)
24	—	5040 (41.5)	5170 (57)	5150 (65)	5000 (70)
26	—	4330 (36)	4450 (54)	4520 (63)	4400 (68.5)
28	—	3740 (29)	3850 (51)	3930 (60.5)	3880 (66.5)
30	—	3250 (20)	3340 (47.5)	3410 (58.5)	3420 (65)
31.5	—	2910 (0)	3010 (45)	3080 (56.5)	3120 (63.5)
34	—	—	2530 (40)	2590 (53.5)	2640 (61)
36	—	—	2200 (36)	2260 (51)	2310 (59)
38	—	—	1910 (31)	1960 (48.5)	2010 (57)
40	—	—	1660 (25)	1700 (45.5)	1750 (55)
42	—	—	1410 (17.5)	1470 (42.5)	1510 (53)
43.5	—	—	1230 (0)	1310 (40.5)	1350 (51.5)
46	—	—	—	1070 (36)	1110 (48.5)
48	—	—	—	890 (32.5)	930 (46.5)
50	—	—	—	720 (28)	780 (44)
52	—	—	—	570 (23)	630 (41.5)
54	—	—	—	430 (16)	500 (38.5)
55.5	—	—	—	330 (0)	410 (36.5)
58	—	—	—	—	270 (32.5)

NOTE: () Boom angles are in degrees.

80088569

THIS CHART IS ONLY A GUIDE AND SHOULD NOT BE USED TO OPERATE THE CRANE.

The individual crane's load chart, operating instructions and other instructional plates must be read and understood prior to operating the crane

Load chart

Imperial 85%

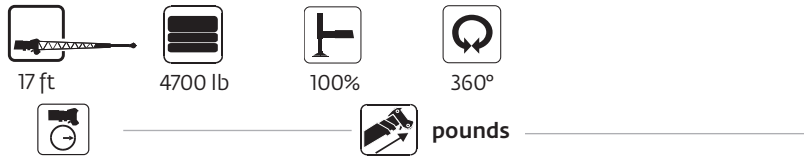

Main Boom Angle (°)	0° OFFSET		15° OFFSET		30° OFFSET
	Up to 59' boom length	With 70.5' boom length	Up to 59' boom length	With 70.5' boom length	Any boom length
80	—	—	5000	5000	3500
75	7500	—	4400	4400	3100
70	6100	—	3900	3900	2800
65	5000	4600	3500	3500	2550
60	4300	3800	3150	3150	2350
55	3800	3300	2850	2850	2200
50	3400	2900	2600	2600	2100
45	3050	2600	2400	2400	2000
40	2800	2400	2250	2250	1950
35	2600	2150	2150	2050	1900
30	2400	1930	2080	1850	1830
25	2300	1750	2050	1720	—
20	2200	1600	2000	1590	—
15	2100	1500	1950	1520	—
10	2050	1460	—	—	—
5	2020	1450	—	—	—
0	2000	1440	—	—	—

80088570

NOTES:

1. 17 ft boom extension may be used for single line lifting service only.
2. **WARNING:** Operation of this machine with heavier loads than the capacities listed is strictly prohibited. Machine tipping with boom extension occurs rapidly and without advance warning.

*THIS CHART IS ONLY A GUIDE AND SHOULD NOT BE USED TO OPERATE THE CRANE.
The individual crane's load chart, operating instructions and other instructional plates must be read and understood prior to operating the crane*

Load chart

Imperial 85%



Boom



4700 lb



Stationary



Defined arc
over front



Stationary



360°



Pick & Carry



Over front



pounds

ft	Defined Arc 15° Over Front	Stationary 360°
6	30,000	21,000
8	24,900	17,900
10	21,000	15,900
12	18,000	13,000
14	15,650	10,000
16	13,300	7920
18	10,900	6410
20	9460	5780
22	8060	4880
24	6960	4140
26	6050	3520
28	3500	2990
30	4670	2540
32	4130	2160
34	3670	1820
36	3260	1530
38	2900	1270
40	2590	1040
42	2300	830
44	2280	720
46	2050	610
48	1840	500
50	1650	390
52	1480	280
54	1320	—
56	1220	—
58	1080	—
60	950	—
62	840	—
64	730	—
66	620	—
67	570	—

80088571

1. Capacities are in pounds and do not exceed 75% of tipping loads as determined by test in accordance with SAE J765.
2. Capacities are applicable to machines equipped with 17.5x25 at 110 psi cold inflation pressure.
3. Capacities are applicable only with machine on a smooth, level and firm surface.
4. Defined Arc - Over front includes 15° on either side of longitudinal centerline of machine.
5. All rubber lifting depends on proper tire inflation, capacity and condition. Capacities must be reduced for lower tire inflation pressures. Damaged tires are hazardous to safe operation of crane.
6. For pick and carry operation, the boom, using the shortest practical boom length, must be centered over front of machine. Maximum speed is 2.5 mph.
7. On rubber lifting with boom extension not permitted.

THIS CHART IS ONLY A GUIDE AND SHOULD NOT BE USED TO OPERATE THE CRANE.

The individual crane's load chart, operating instructions and other instructional plates must be read and understood prior to operating the crane

Working range



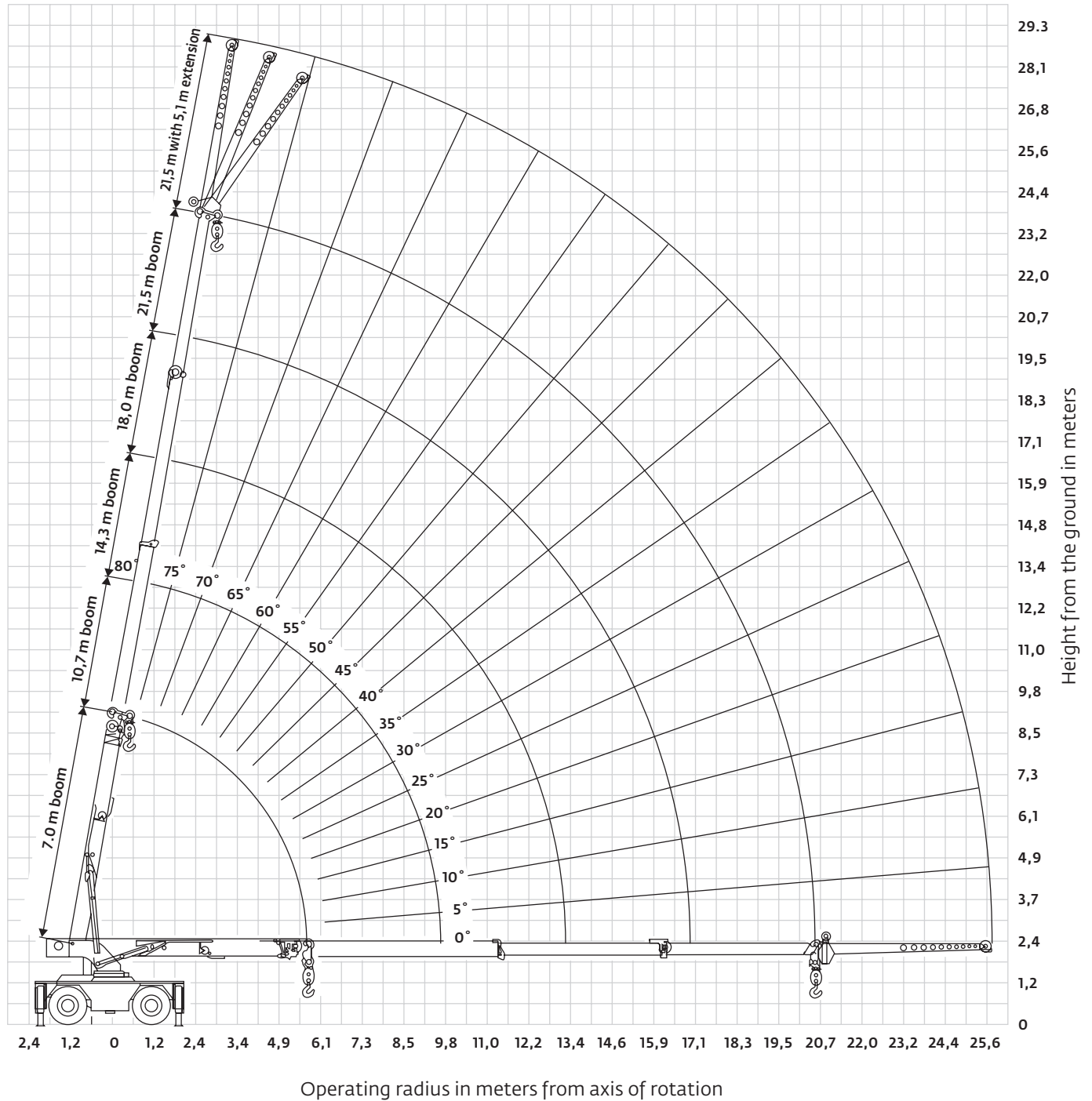



Metric 85%





*THIS CHART IS ONLY A GUIDE AND SHOULD NOT BE USED TO OPERATE THE CRANE.
The individual crane's load chart, operating instructions and other instructional plates must be read and understood prior to operating the crane*

Load chart

Metric 85%









 /
 

 7 m - 21,5 m 2131,9 kg 100% (360°) 0% (front/rear ± 15° defined arc)





kilograms

m	7,0	10,7	14,3	18,0	21,5
2,6	22 650 (64,5)	15 550 (73,5)	15 225 (78,5)	—	—
3	17 575 (60)	15 650 (76,5)	14 975 (76,5)	12 600 (80)	—
3,7	15 825 (54)	14 250 (67)	13 275 (74)	11 725 (78)	—
4,3	14 175 (47)	12 900 (63,5)	11 950 (71)	10 925 (76)	8255 (79)
4,9	12 100 (39)	11 825 (59,5)	10 875 (68,5)	10 150 (74)	7595 (77,5)
5,5	10 500 (29)	10 650 (55,5)	10 000 (66)	9430 (72)	7030 (75,5)
5,9	9545 (0)	9695 (52)	9480 (63,5)	8880 (70,5)	6645 (74,5)
6,7	—	8375 (46)	8450 (60)	8105 (67,5)	6075 (72)
7,3	—	7525 (41)	7595 (57)	7390 (65)	5670 (70,5)
7,9	—	6620 (36)	6735 (54)	6440 (63)	5330 (68,5)
8,5	—	5780 (29)	5915 (51)	5965 (60,5)	5010 (67)
9,1	—	5100 (20)	5260 (47,5)	5305 (58,5)	4445 (65,5)
9,6	—	4670 (0)	4830 (45)	4875 (56,5)	4260 (64)
10,4	—	—	4240 (40)	4300 (53,5)	4010 (61,5)
11,0	—	—	3835 (36)	3895 (51)	3810 (60)
11,6	—	—	3480 (31)	3550 (48,5)	3,600 (57)
12,2	—	—	3175 (25)	3240 (45,5)	3295 (55)
12,8	—	—	2900 (17,5)	2970 (42,5)	3030 (53)
13,3	—	—	2720 (0)	2720 (40,5)	2840 (51,5)
14,0	—	—	—	2465 (36)	2575 (48,5)
14,6	—	—	—	2285 (32,5)	2380 (46,5)
15,2	—	—	—	2120 (28)	2200 (44)
15,8	—	—	—	1970 (23)	2045 (41,5)
16,5	—	—	—	1830 (16)	1900 (38,5)
16,9	—	—	—	1730 (0)	1795 (36,5)
17,7	—	—	—	—	1640 (32,5)
18,3	—	—	—	—	1525 (29)
18,9	—	—	—	—	1420 (25)
19,5	—	—	—	—	1320 (20)
20,1	—	—	—	—	1230 (13)
20,4	—	—	—	—	1185 (0)

NOTE: () Boom angles are in degrees. 80090342

 7 m - 21,5 m 2131,9 kg 0% 360°



kilograms





m	7,0	10,7	14,3	18,0	21,5
2,6	11 950 (63,5)	10 875 (73)	9930 (78)	—	—
3	9430 (59)	8750 (70,5)	8115 (76)	7550 (79,5)	—
3,7	7255 (52,5)	6845 (67)	6440 (73,5)	6055 (77,5)	—
4,3	5575 (45,5)	5555 (63)	5260 (71)	4985 (75,5)	4760 (79)
4,9	4465 (37)	4600 (59,5)	4400 (68,5)	4205 (73,5)	4020 (77)
5,5	3660 (26)	3795 (55,5)	3730 (65,5)	3585 (71,5)	3440 (75,5)
5,9	3,215 (0)	3310 (52)	3320 (63,5)	3200 (70)	3085 (74)
6,7	—	2675 (46,5)	2740 (60)	2675 (67,5)	2590 (72)
7,3	—	2285 (41,5)	2345 (57)	2335 (65)	2265 (70)
7,9	—	1960 (36)	2015 (54)	2050 (63)	1995 (68,5)
8,5	—	1695 (29)	1745 (51)	1780 (60,5)	1755 (66,5)
9,1	—	1470 (20)	1515 (47,5)	1545 (58,5)	1550 (65)
9,6	—	1315 (0)	1365 (45)	1395 (56,5)	1415 (63,5)
10,4	—	—	1145 (40)	1170 (53,5)	1195 (61)
11,0	—	—	995 (36)	1025 (51)	1045 (59)
11,6	—	—	865 (31)	885 (48,5)	910 (57)
12,2	—	—	750 (25)	770 (45,5)	790 (55)
12,8	—	—	640 (17,5)	665 (42,5)	680 (53)
13,3	—	—	555 (0)	590 (40,5)	610 (51,5)
14,0	—	—	—	485 (36)	500 (48,5)
14,6	—	—	—	400 (32,5)	420 (46,5)
15,2	—	—	—	325 (28)	350 (44)
15,8	—	—	—	255 (23)	285 (41,5)
16,5	—	—	—	195 (16)	225 (38,5)
16,9	—	—	—	145 (0)	185 (36,5)
17,7	—	—	—	—	120 (32,5)

NOTE: () Boom angles are in degrees. 80090342

THIS CHART IS ONLY A GUIDE AND SHOULD NOT BE USED TO OPERATE THE CRANE.
The individual crane's load chart, operating instructions and other instructional plates must be read and understood prior to operating the crane

Load chart

Metric 85%

 18 m - 21,5 m
  5,2 m
  2131,9 kg
  100%
  360°

  kilograms

Main Boom Angle (°)	0° OFFSET		15° OFFSET		30° OFFSET
	To 18 m boom length	To 21,5 m boom length	To 18 m boom length	To 21,5 m boom length	Any boom length
80	–	–	2270	2270	1590
75	3400	–	2000	2000	1410
70	2770	–	1770	1770	1270
65	2270	2090	1590	1590	1160
60	1950	1720	1430	1430	1070
55	1720	1500	1290	1290	1000
50	1540	1320	1180	1180	950
45	1380	1180	1090	1090	910
40	1270	1090	1020	1020	880
35	1180	980	980	930	860
30	1090	880	940	840	830
25	1040	790	930	780	–
20	1000	730	910	720	–
15	950	680	880	690	–
10	930	660	–	–	–
5	920	660	–	–	–
0	910	650	–	–	–

80090346

NOTES:

1. 5,2 m boom extension may be used for single line lifting service only.
2. **WARNING:** Operation of this machine with heavier loads than the capacities listed is strictly prohibited. Machine tipping with boom extension occurs rapidly and without advance warning.

*THIS CHART IS ONLY A GUIDE AND SHOULD NOT BE USED TO OPERATE THE CRANE.
The individual crane's load chart, operating instructions and other instructional plates must be read and understood prior to operating the crane*

Load chart

Metric 85%



Boom



2131,9 kg



Stationary



Defined arc
over front



Stationary



360°



Pick & Carry



Over front



kilograms

m	Defined Arc 15° Over Front	Stationary 360°
1,8	13 600	9525
2,4	11 300	8115
3,0	9525	6800
3,7	8160	5895
4,3	7095	4535
4,9	6030	3590
5,5	4940	2905
6,1	4290	2620
6,7	3655	2210
7,3	3155	1875
7,9	2740	1595
8,5	2400	1355
9,1	2115	1150
9,8	1870	975
10,4	1660	825
11,0	1475	690
11,6	1315	575
12,2	1170	470
12,8	1040	375
13,4	1030	325
14,0	930	275
14,6	830	225
15,2	745	175
15,0	670	125
16,5	595	–
17,1	550	–
17,7	485	–
18,3	430	–
18,9	380	–
19,5	330	–
20,1	280	–
20,4	255	–

80090347

1. Capacities are in kilograms and do not exceed 75% of tipping loads as determined by test in accordance with SAE J765.
2. Capacities are applicable to machines equipped with 17.5x25 at 7.6 bar cold inflation pressure.
3. Capacities are applicable only with machine on a smooth, level and firm surface.
4. Defined Arc - Over front includes 15° on either side of longitudinal centerline of machine.
5. All rubber lifting depends on proper tire inflation, capacity and condition. Capacities must be reduced for lower tire inflation pressures. Damaged tires are hazardous to safe operation of crane.
6. For pick and carry operation, the boom, using the shortest practical boom length, must be centered over front of machine. Maximum speed is 4,0 km/h.
7. On rubber lifting with boom extension not permitted.

THIS CHART IS ONLY A GUIDE AND SHOULD NOT BE USED TO OPERATE THE CRANE.

The individual crane's load chart, operating instructions and other instructional plates must be read and understood prior to operating the crane

Transportation and lifting data

- LIFTING OF ENTIRE CRANE OR MAJOR CRANE ASSEMBLIES MUST BE ACCOMPLISHED BY UTILIZING SPECIFIC FITTINGS INDICATED ON ADJACENT CHART. USE OF FITTINGS FOR PURPOSES OTHER THAN THOSE DESIGNATED ON CHART IS PROHIBITED. FITTING CAPACITIES ARE MAXIMUM ALLOWABLE LOADS PER INDIVIDUAL FITTING.
- RIGGING PERSONNEL SHALL BE RESPONSIBLE FOR PROPER SELECTION AND PLACEMENT OF ALL SLINGS AND LOAD HANDLING DEVICES.
- DIMENSIONS AND WEIGHTS SHOWN ARE ESTIMATED FOR LARGEST CONFIGURATION AVAILABLE. WEIGHTS DO NOT INCLUDE BOOM EXTENSION AND OR JIB, UNLESS OTHERWISE INDICATED.
- RIGGING PERSONNEL SHALL VERIFY DIMENSIONS AS REQUIRED FOR CLEARANCE.
- DO NOT USE COUNTERWEIGHT LIFT LOCATIONS OR BOOM SLING POINT FOR LIFTING OR TIE DOWN OF ENTIRE CRANE.
- LIFTING OF THE COUNTERWEIGHT TO BE ACCOMPLISHED WITH A PROPERLY RATED 1/2 INCH EYEBOLT.

FITTING	NO. / UNIT	LIFT	TOW	TIE DOWN	BOOM	CWT	CAPACITY-TONNES [TONS]						
							LIFT	LIFT	LIFT	TOW	TIE DOWN		
											FORE & AFT	SIDE	DOWN
A	4	X	X	X			9,1 [10]	27,2 [30]	27,2 [30]	0,9 [1]	27,2 [30]		
B	4				X		1,8 [2]						
C	1					X	0,9 [1]						
D	1					X	0,9 [1]						

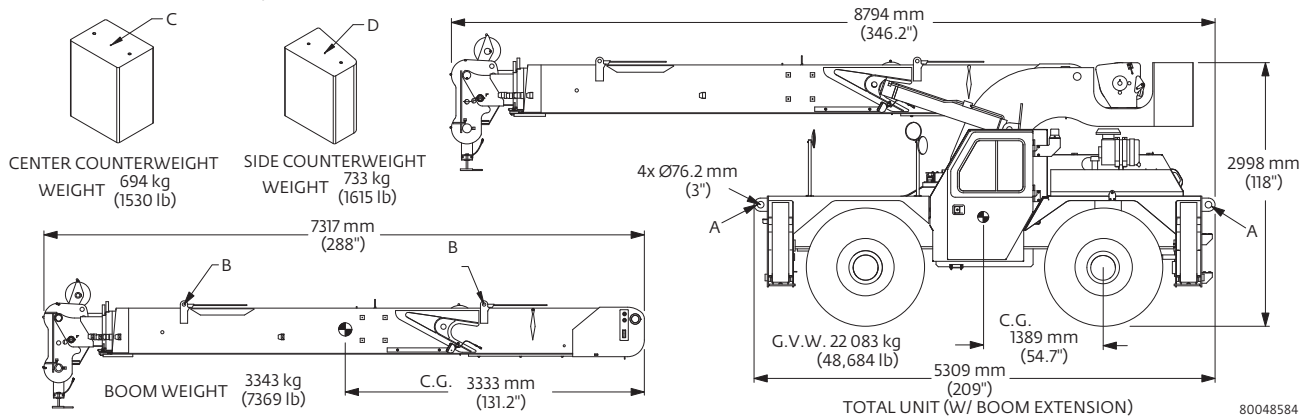

LOAD DISTRIBUTION CHART FOR CARRY DECK

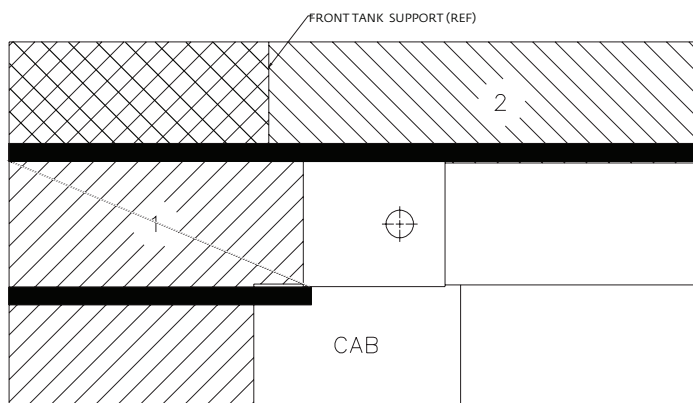

Maximum Allowable Uniformly Distributed Load

AREA 1
13 610 kg
(30,000 lb)

OR

AREA 2
6805 kg
(15,000 lb)

- Maximum travel speed with any or all loads – 4,0 km/h (2.5 mph)
- Loads to be transported on smooth level firm surfaces only.
- Boom must be retracted and in center forward position, and lowered as much as the load allows.
- Pick and carry loads may be transported on either Deck Area 1 or Deck Area 2; combined loading of Deck Area 1 and Deck Area 2 not permitted.
- Lifting is not permitted when carry deck is loaded except for loading and unloading carry deck.
- The maximum pick and carry loads may be transported on Deck Area 1 provided the load is centered over the front axle and cribbed directly on the frame rails.

*THIS CHART IS ONLY A GUIDE AND SHOULD NOT BE USED TO OPERATE THE CRANE.
The individual crane's load chart, operating instructions and other instructional plates must be read and understood prior to operating the crane*

Load handling

WEIGHT REDUCTIONS FOR LOAD HANDLING DEVICES

5,2 m (17 ft) FIXED OFF EXTENSION	
*Stowed -	N/A
*Erected	508 kg (1120 lb)

*Reduction of main boom capacities

When lifting over swingaway and/or jib combinations, deduct total weight of all load handling devices reeved over main boom nose directly from swingaway or jib capacity.

HOOK BLOCKS and HEADACHE BALLS:	
22,7 t (25 ton), 2 sheave hook block	215 kg+ (475 lb+)
5,7 t (6.25 ton) headache ball	48 kg+ (105 lb+)

+Refer to rating plate for actual weight.

NOTE: All load handling devices and boom attachments are considered part of the load and suitable allowances MUST BE MADE for their combined weights. Weights are for Grove furnished equipment.

TIRE INFLATION - BAR			
SIZE (FRONT & REAR)	LOAD RANGE	LOAD SPEED INDEX	LIFTING SERVICE, GENERAL TRAVEL & EXTENDED TRAVEL
			STATIC, CREEP & 4,0 km/h (2.5 mph)
OTR 17.5x25 E3/L-3	20 PR	-----	7,6 (110)

*THIS CHART IS ONLY A GUIDE AND SHOULD NOT BE USED TO OPERATE THE CRANE.
The individual crane's load chart, operating instructions and other instructional plates must be read and understood prior to operating the crane*

Load handling

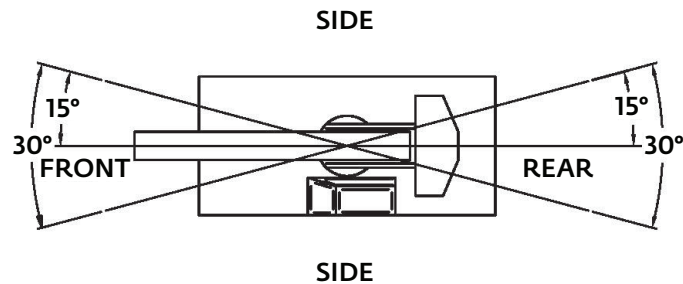

CAPACITY REDUCTIONS FOR SYNTHETIC ROPE USE

If synthetic rope is installed on the hoist, the following capacity reductions apply:

	Main boom charts	Extension charts
Outriggers fully extended - 360° or retracted over front/rear	36 kg (80 lb)	0 kg (0 lb)
Outriggers retracted 360°	122 kg (270 lb)	N/A
On rubber	45 kg (100 lb)	N/A

LINE PULLS AND REEVING INFORMATION

HOISTS	CABLE SPECS.	PERMISSIBLE LINE PULLS	NOMINAL CABLE LENGTH
Main	16 mm (5/8") 6x19 Class Bridon (XXIPS/IWRC) Min. breaking strength 20 595 kg (45,400 lb)	5670 kg* (12,500 lb)	119 m (390 ft)
Main	18 mm Synthetic K™100 Hoist Rope (ISO) Min. breaking strength 28 895 kg (63,700 lb)	5780 kg* (12,740 lb)	123 m (407 ft)

The approximate weight of 16 mm (5/8") wire rope is 1,1 kg/m (0.72 lb/m).

The approximate weight of 18 mm synthetic rope is 0,24 kg/m (0.16 lb/m).

*With certain boom and hoist tackle combinations, the allowable line pull may be limited by hoist performance. Refer to Hoist Performance table for lift planning to ensure adequate hoist performance on drum rope layer required.

*THIS CHART IS ONLY A GUIDE AND SHOULD NOT BE USED TO OPERATE THE CRANE.
The individual crane's load chart, operating instructions and other instructional plates must be read and understood prior to operating the crane*

Specifications

Superstructure



Boom

7,21 m – 21,6 m (23 ft 8 in - 71 ft) full power main boom. Four-section boom with three (3) powered sections.

Maximum tip height: 24,0 m (79 ft).



Optional swingaway extension

5,1 m (17 ft) offsettable swingaway extension. Offsets 0°, 15° and 30° via pivoting boom nose. Stows alongside base boom section.

Maximum tip height: 28,9 m (95 ft).



Boom nose

Two nickel plated steel sheaves mounted on heavy-duty tapered roller bearings with removable pin-type rope guards. Quick reeve type boom nose with four-position (0°, +30°, +60°, and + 80°) pivoting to minimize head height requirements. Lowers head height by 0,6 m (2 ft).



Boom elevation

Two double acting hydraulic cylinders with integral holding valves provides elevation from -0° to +80°.



Anti-two block device

Standard anti-two block device, which, when activated, provides an audible warning to the operator and "locks-out" all functions whose movement can cause two-blocking.



Rated Capacity Limiter (RCL)

Full-color, graphical display of boom angle, boom length, boom radius, rated load, and calculated load. Allows for operator inputs to set the crane configuration. RCL system is hardwired and calculates load via pressure transducers in the lift cylinder. Display includes a color-coded light bar and audible alarm with function cut-out if load exceeds the load chart parameters.



Swing

Ball bearing swing circle with 360° continuous rotation. Hydraulic motor driven pinion with brake.

Maximum speed: 2,5 rpm



Hydraulic system

One pressure compensated variable displacement axial piston pump with load sensing.

Maximum output of: 208 lpm (55 gpm).

Maximum operating pressure: 241 bars (3500 psi).

Four-section valve bank, chassis mounted, operated via dash mounted, hydraulic pilot controls. 208 L (55 gal) hydraulic reservoir with sight level gauge and steel side plating to guard against side impacts.

5 micron return line filter with full flow by-pass protection and service indicator.



Hoist specifications

Piston motor driven with automatic spring-applied / hydraulically released wet brake. Drum rotation indicator in the hoist joystick control and hoist direction indicator light on dashboard.

Maximum hoist pull (first layer): 6804 kg (15,000 lb)

Maximum permissible single line pull: 5670 kg (12,500 lb)
(3.5:1 design factor)

Maximum single line speed: 61 m/min (200 fpm)

Rope construction: 6X19 XXIPS/IWRC

Rope diameter: 16 mm (5/8 in)

Rope length: Main hoist: 119 m (390 ft)

Maximum rope stowage: Main hoist: 151 m (495 ft)

Carrier



Chassis

High-strength alloy frame constructed with integral outrigger housings; front and rear lifting, tie-down, and towing lugs. 60 ft² carrydeck size with 13 608 kg (30,000 lb) deck only carrying capacity. Deck coated with anti-skid treatment.



Outriggers

Hydraulic telescoping beam with vertical jack at the four corners provides extended and down and retracted and down lifting capacities. Integral holding valves on the jack cylinders.

Outrigger pad size:

29,2 cm x 29,2 cm (11.5 in x 11.5 in)

Maximum outrigger pad load:

18 825 kg (41,500 lb) / 339 p.s.i.



Outrigger controls

Independent outrigger control rocker switches for beam or jack selection with separate extend/retract rocker switch. 360° bubble level located inside cab.



Engine (EPA Tier 4F)

Cummins QSB 4.5 L, four-cylinder, turbo-charged diesel rated at 97 kW (130 hp) at 2500 rpm. Standard 110 V engine block heater and cold weather intake grid heater.

Diesel oxidation/catalyst and SCR device to meet EPA Tier 4 Final emissions, combined with a Cummins direct air flow, two-stage air filter system with built-in pre-cleaner.

Maximum torque: 622 N-m (459 ft lb) at 1500 rpm.

Note: Tier 4F engine required in North American countries.

Fuel requirements: Maximum of 15 ppm ultra-low sulfur diesel fuel and diesel exhaust fluid (DEF).



Engine (EPA Tier 3)

Cummins QSB 4,5L, four cylinder / turbo-charged diesel rated at 97 kW (130 bhp) (gross) at 2500 rpm. Standard 110 V engine block heater and cold weather intake grid heater. Engine hour meter located inside operators compartment.

Maximum gross torque: 622 N-m (459 ft lb) at 1500 rpm.

Note: Required for sale outside of North American and European Union countries.

Fuel requirements: Maximum of 5000 ppm. Sulfur diesel fuel.

**Denotes optional equipment*

Specifications

Carrier *(cont'd)*



Fuel tank capacity

189 L (50 gal)
DEF (diesel exhaust fluid): 19 L (5 gal)



Transmission

Powershift with four speeds forward and three speeds reverse. Stalk mounted direction shifter with rotary gear selection.



Operators control station

Frame mounted, open air style control station with cab shell includes all crane functions, driving controls, and overhead safety glass. Other standard equipment includes a suspension seat with seat belt, hour meter, sight level bubble, and 1,1 kg (2.5 lb) fire extinguisher.

The dash panel includes a multi-cluster gauge showing fuel, water temperature, DEF gauge, battery voltage and engine fault codes. An engine monitoring indicator lamp shows engine warning, stop engine, wait to start, transmission high temperature, low brake system pressure, hydraulic oil temperature and DEF status indicators. The RCL display is mounted to the top of the front dash.



*Operators control station enclosed

Includes the standard cab shell with the addition of front, rear, and right side glass, a split (2 piece) hinged door with sliding glass, front windshield wiper and washer, hot water heater and defroster with fan and cab dome light are included.



Electrical system

Two 12 V maintenance-free batteries, 730 CCA each at 0°. 130 amp alternator.



Drive

Two wheel (rear drive) or four wheel selection, front and rear axle drive with planetary hubs and limited slip differential.



Steering

Standard three steering modes. Front two-wheel, four-wheel coordinated, and four-wheel crab steer with electronic self alignment, three-position rocker selector on dash panel.

Outside turning radius:

Two-wheel steer: 7,32 m (24 ft)

Four-wheel steer: 4,04 m (13 ft 3 in)



Axles

Front: Drive/steer with differential and planetary reduction hubs, axle is rigid mounted to frame.

Rear: Drive/steer with differential and planetary reduction hubs, axle is pivot mounted to frame allows up to 3.5° of oscillation.



Oscillation lockouts

Manual switch to engage and disengage the rear axle lockouts. Engage when lifting on rubber and in crab steer mode, disengage to allow oscillation when traveling over rough terrain.



Brakes

Hydraulic actuated internal wet-disc service brake acting on all four wheels. Dash mounted toggle switch with light for activating or release of the dry disc parking brake mounted on the transmission output yoke.



Tires

Standard: 17.5 x 25 bias

Optional: 17.5R25 radials



Light

Full lighting including turn indicators, head, tail, brake and hazard warning lights recessed mounted.



Maximum speed

31,22 km/h (19.4 mph)



Gradeability (theoretical)

63%..... (at engine stall) no load

38%.....(at engine stall) with 13 608 kg (30,000 lb) deck load

Gross vehicle weight (GVW)

Open cab: 20 623 kg (45,465 lb)

Enclosed cab: 20 729 kg (45,698 lb)

Miscellaneous standard equipment

- 22 t (25 USt) two-sheave “painted block” hook block, with “quick reeve.”
- Back-up motion alarm
- Outrigger motion alarm
- Dual rear-view mirrors
- Hoist drum rotation indicator

*Optional equipment

- Auxiliary lighting: includes amber strobe light and boom mounted work lights
- Convenience package: includes front and rear pintle hitch and headlight/taillight grille covers
- Enclosed cab package: includes heater and defroster, cab dome light, all window glass, and two-piece split door
- Offsetable swing away boom extension with hook and ball
- Air conditioner
- Wire rope third wrap indicator with hoist function cut-out
- 3629 kg (8000 lb) below-deck mounted tow winch
- Foam-filled tires
- RCL system includes a full-color graphical display, work area definition (WADS), and is datalogger capable (requires Crane Care activation)
- Below-deck winch

**Denotes optional equipment*

Symbol glossary



Axles



Drive



Hoist



Rated Capacity Limiter (RCL)



Boom



Electrical system



Hook block



Rotation



Boom elevation



Engine



Hydraulic system



Speed



Boom extension



Extension



Insert



Steering



Boom length



Frame



Lights



Suspension



Boom nose



Fuel tank capacity



Oil



Swing



Brakes



Gear



Outrigger controls



Tires



Cab



Grade



Outriggers



Transmission



Counterweight



Heavy-duty jib



Radius

Notes

Notes

Notes

The Manitowoc Company, Inc.

Regional headquarters

Americas

Milwaukee, Wisconsin, USA

Tel: +1 414 760 4600

Shady Grove, Pennsylvania, USA

Tel: +1 717 597 8121

Europe and Africa

Dardilly, France - TOWERS

Tel: +33 (0) 4 72 18 20 20

Wilhelmshaven, Germany - MOBILE

Tel: +49 (0) 4421 294 0

APAC

Shanghai, China

Tel: +86 21 6457 0066

Singapore

Tel: +65 6264 1188

Middle East and India

Dubai, UAE

Tel: +971 4 8862677

This document is non-contractual. Constant improvement and engineering progress make it necessary that we reserve the right to make specification, equipment, and price changes without notice. Illustrations shown may include optional equipment and accessories and may not include all standard equipment.

