

# Grove YB7725

## Product Guide

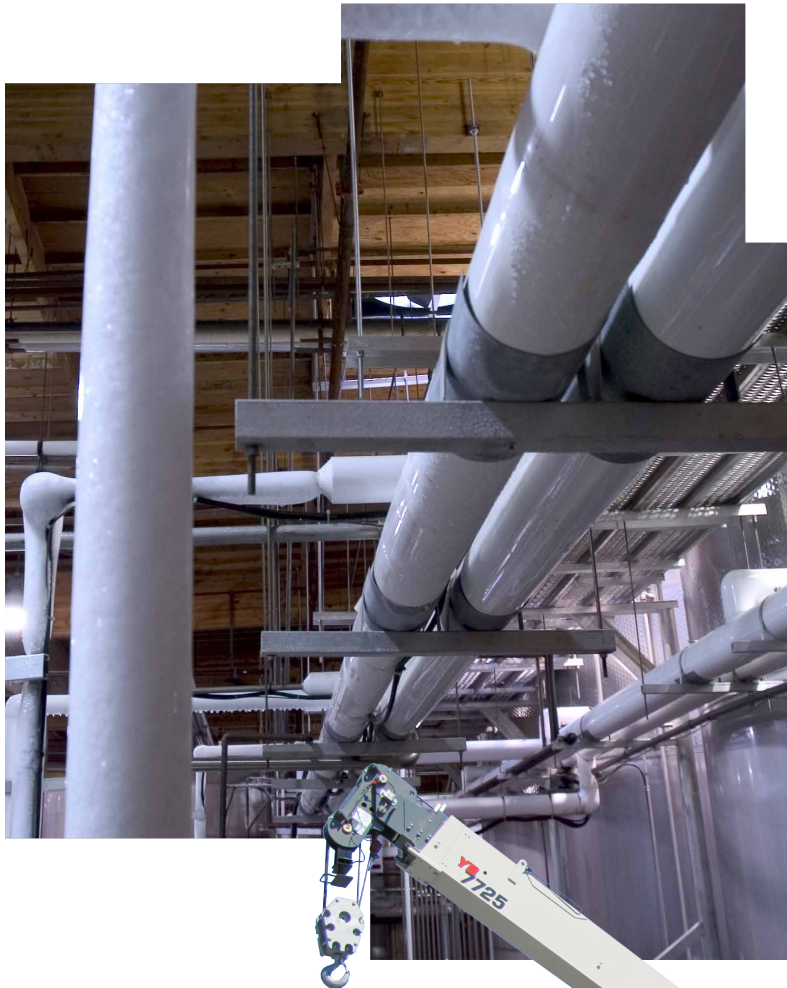

### Features

- 22 t (25 USt) capacity
- 21,6 m (71 ft) four-section full power boom
- 13,6 t (15 USt) deck carrying capacity
- Tilt steering wheel
- Load sensing piston hydraulic pump
- Proportional hydraulic controls





### The reach and capacity to get the job done

A 5,1 m (17 ft) swingaway extension added to the 21,6 m (71 ft) main boom provides an impressive 28,9 m (95 ft) tip height with a capacity of 2268 kg (5000 lb). A galvanized down-haul ball is included with the extension.

### Split door design

The “new” split door design, offered with the optional enclosed cab, allows for the top half to be left open while keeping the bottom half closed for safety.



Specifications

4

Dimensions

7

Range diagram

9

Load chart

10

DIN/ISO range diagram

12

DIN/ISO load chart

13

Symbols glossary

15



### Hook block

A galvanized coated hook block is provided as standard to help eliminate rusting of this important crane component.



### Operator cab

Hydraulic proportional joystick controls, automotive dash layout, tilt steering wheel, and suspension seat enhances operator comfort and ease of use.

# Specifications

## Superstructure

### Boom

7,21 m – 21,6 m (23 ft 8 in - 71 ft) full power main boom. Four-section boom with three (3) powered sections.

Maximum tip height: 24,0 m (79 ft).

### \*Offsettable swingaway extension

5,1 m (17 ft) offsettable swingaway extension. Offsets 0°, 15°, and 30° via pivoting boom nose. Stows alongside base boom section.

Maximum tip height: 28,9 m (95 ft).

### Boom nose

Two nickel plated steel sheaves mounted on heavy duty tapered roller bearings with removable pin-type rope guards. Quick reeve type boom nose with four-position (0°, +30°, +60°, and +80°) pivoting to minimize head height requirements. Lowers head height by 0,6 m (2 ft).

### Boom elevation

Two double acting hydraulic cylinders with integral holding valves provides elevation from -0° to +80°.

### Anti-two block device

Standard anti-two block device, which, when activated, provides an audible warning to the operator and “locks-out” all functions whose movement can cause two-blocking.

### Load indicator (LSI)

A simple effective and easy to use load indicating system used in conjunction with the anti-two block system to assist the operator in efficient operation of the unit within the limits of the load chart. The display panel displays the hook load and cuts-out the telescope and boom lift down function when a load limit is exceeded. The warning is by a flashing light on the display panel. In conjunction with the load display panel (receiver) there is a wireless transmitter and load sensing pin attached to the boom head that transmits the hook load to the display panel.

(**wireless system**)

### \*Load Moment Indicator (LMI)

“Graphics Display” of boom angle, boom length, boom radius, capacity, and allows for operator input to set the limit parameters based on the load chart. Displays color coded light bar and audible alarm with function cut-out if load exceeds the load chart parameters.

(**hardwired system**)

### Swing

Ball bearing swing circle with 360° continuous rotation. Hydraulic motor driven pinion with brake. Maximum speed: 2.5 rpm

### Hydraulic system

One pressure compensated variable displacement axial piston pump with load sensing combined with two (2) gear pumps.

Maximum output of: 238 LPM (79 GPM).

Maximum operating pressure: 248 bars (3600 psi).

Six section valve bank, chassis mounted, operated via dash mounted, pilot pressure hydraulic joysticks. 227 L (60 gal) hydraulic reservoir with sight level gauge and steel side plating to guard against side impacts.

10 micron return line filter with full flow by-pass protection and service indicator.

### Hoist specifications

Piston motor driven with automatic spring applied / hydraulically released wet brake.

Maximum hoist pull (first layer): 6804 kg (15,000 lb)

Maximum permissible single line pull:  
5670 kg (12,500 lb) (3.5:1 design factor)

Maximum single line speed: 61 m/min (200 fpm)

Rope construction: 6X19 XIPS/IWRC

Rope diameter: 16 mm (5/8 in)

Rope length:  
Main hoist: 119 m (390 ft)

Maximum rope stowage:  
Main hoist: 151 m (495 ft)

## Carrier

### Chassis

High strength alloy frame constructed with integral outrigger housings; front and rear lifting, tie-down, and towing lugs. 60 ft<sup>2</sup> carrydeck size with 13 608 kg (30,000 lb) deck only carrying capacity. Deck coated with anti-skid treatment.

### Outriggers

Two-stage hydraulic telescoping beam with vertical jack at the four corners provides extended and down and retracted and down lifting capacities. Integral holding valves on both beam and jack cylinders.

Outrigger pad size:

29,2 cm x 29,2 cm (11.5 in x 11.5 in)

Maximum outrigger pad load:

20 321 kg (44,800 lb) / 339 p.s.i.

### Outrigger controls

Independent outrigger control rocker switches for beam or jack selection with separate extend/retract rocker switch. 360° bubble level located inside cab.

### Engine (Tier IV)

Cummins QSB 4.5 L, four cylinders, turbo-charged diesel rated at 97 kW (130 hp) at 2500 rpm. Standard 110V engine block heater and cold weather intake grid heater.

Diesel Oxidation/Catalyst, stainless steel, muffler to meet 2012 EPA emissions, combined with a Cummins direct air flow, 2 stage cyclonic air filter system.

Maximum torque: 620 N-m (457 ft lb) at 1500 rpm.

**Note:** Tier IV engine Required in North American and European Union countries.

### Engine (Tier III)

Cummins QSB 4.5L, four cylinders / turbo-charged diesel rated at 97 kW (130 bhp) (Gross) at 2500 rpm. Standard 110V engine block heater and cold weather “ether” assist system. Engine hour meter located inside operators compartment.

Maximum torque: 370 N-m (273 ft lb) at 2500 rpm.

**Note:** Required for sale outside of North American and European Union countries

### Fuel tank capacity

189 L (50 gal)

Grove YB7725

# Specifications

## Transmission

Powershift with four speeds forward and reverse. Stalk mounted direction shifter with rotary gear selection.

## Operators control station

Frame mounted, open air style control station with cab shell includes all crane functions, driving controls, and overhead safety glass. Other standard equipment includes a suspension seat with seat belt, hourmeter, sight level bubble, and 2.5 lb (1.1 kg) fire extinguisher. The dash panel includes a multi-cluster gauge showing fuel, water temperature, oil pressure, and battery voltage. An engine monitoring indicator strip shows engine warning, stop engine, transmission low pressure, transmission high temperature, and low brake system pressure. The load indicator receiver is mounted to the top of the dash panel.

## \*Operators control station enclosed

Includes the standard cab shell with the addition of front, rear, and right side glass, a split (2 piece) hinged door with sliding glass, front windshield wiper and washer, hot water heater and defroster with fan and cab dome light are included.

## Electrical system

Two 12V maintenance-free batteries, 820CCA at 0°. 63 amp alternator.

## Drive

2 wheel (rear drive) or 4 wheel selection, front and rear axle drive with planetary hubs and limited slip differential.

## Steer

Standard three steering modes. Front two wheel, four-wheel coordinated, and four-wheel crab steer with electronic self alignment, three-position rocker selector on dash panel.

Outside turning radius:

**Two-wheel steer:** 7,32 m (24 ft)

**Four-wheel steer:** 4,04 m (13 ft 3 in)

# Specifications

## Carrier continued

### Suspension/axles

**Front:** Drive/steer with differential and planetary reduction hubs, axle is rigid mounted to frame.

**Rear:** Drive/steer with differential and planetary reduction hubs, axle is pivot mounted to frame allows up to 3.5° of oscillation.

### Oscillation lockouts

Manual switch to engage and disengage the rear axle lockouts. Engage when lifting on rubber and in crab steer mode, Disengage to allow oscillation when traveling over rough terrain.

### Brakes

Hydraulic actuated internal wet-disc service brake acting on all four wheels. Dash mounted toggle switch with light for activating or release of the dry disc parking brake mounted on the transmission output yoke.

### Tires

**Standard:** 17.5 x 25 Bias

**Optional:** 17.5R25 radials

### Lights

Full lighting including turn indicators, head, tail, brake and hazard warning lights recessed mounted.

### Maximum speed

31,3 km/h (19.5 mph)

### Gradeability (theoretical)

63%..... (at engine stall) NO LOAD

38%.....(at engine stall) with 13 608 kg (30,000 lb) DECK LOAD

## Gross vehicle weight (G.V.W.)

**Open cab:** 20 249 kg (44,640 lb)

**Enclosed cab:** 20 354 kg (44,873 lb)

## Miscellaneous standard equipment

22 t (25 USt) Two sheave “galvanize coated” hook block, with “Quick Reeve”.

Back-up motion alarm

Outrigger motion alarm

Dual rear-view mirrors

## \*Optional equipment

- ▶ **AUXILIARY LIGHTING:** includes cab mounted amber flashing light, dual base boom mounted floodlights
- ▶ **CONVENIENCE PACKAGE:** includes front and rear pintle hitch and headlight/taillight grille covers
- ▶ **ENCLOSED CAB PACKAGE:** includes heater and defroster, cab dome light, all window glass, and two piece split door
- ▶ 5,2 m (17 ft) fixed extension
- ▶ Air conditioner
- ▶ Catalytic convertor
- ▶ Hoist drum rotation indicator
- ▶ Wire rope 3rd wrap indicator with hoist function cut-out
- ▶ 3629 kg (8000 lb) below deck mounted tow winch
- ▶ Foam – filled tires

# Dimensions

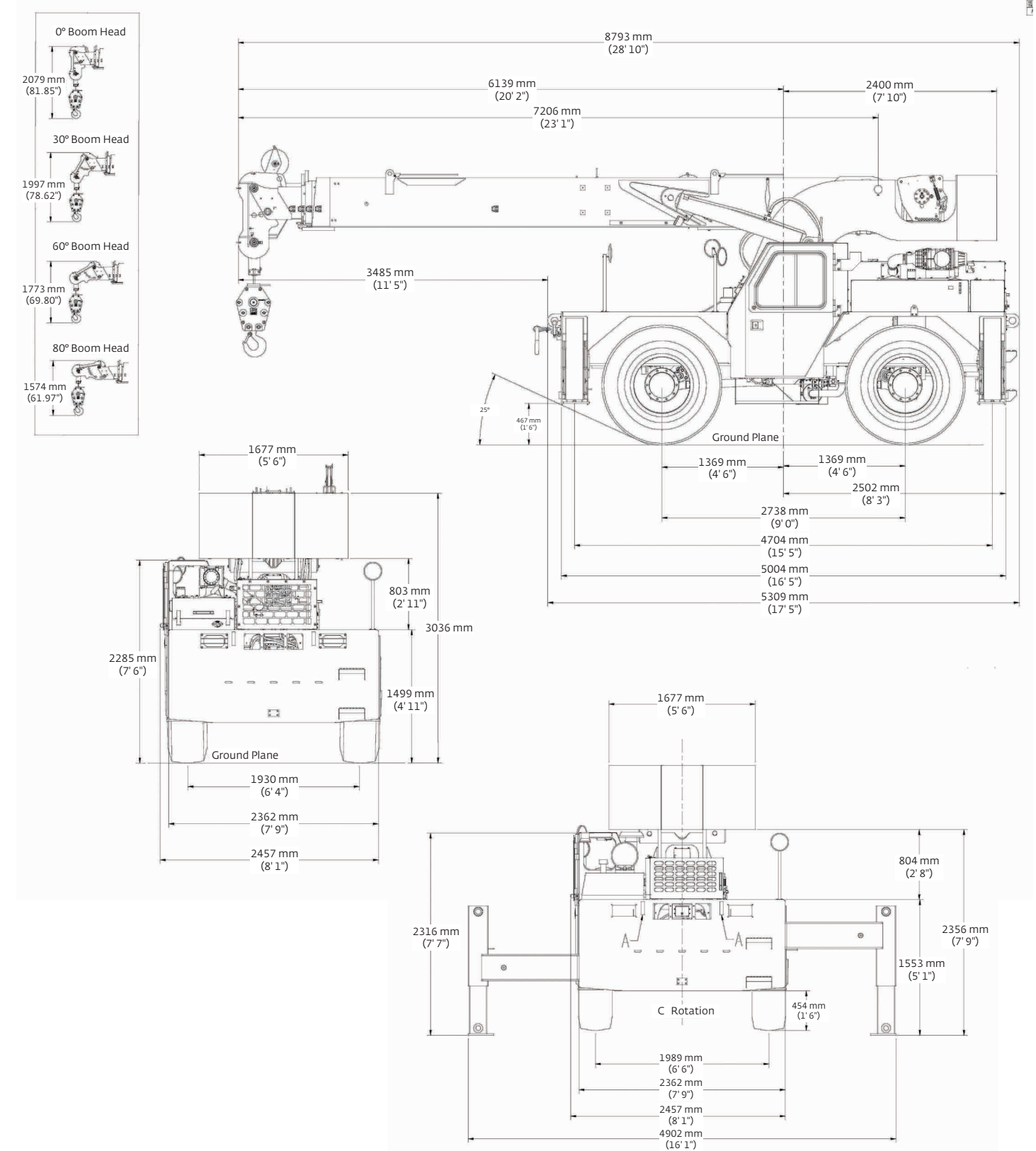

# Dimensions

# Range diagram

Dimensions										
Tire size	A	B	C	D	E	A	B	C	D	E
17.5 x 25	9784 mm (385.2 in)	8047 mm (316.8 in)	7620 mm (300 in)	7300 mm (287.4 in)	4664 mm (183.6 in)	7102 mm (279.6 in)	4968 mm (195.6 in)	4542 mm (178.8 in)	4084 mm (160.8 in)	1890 mm (74.4 in)
	Two-wheel steer					Four-wheel steer				

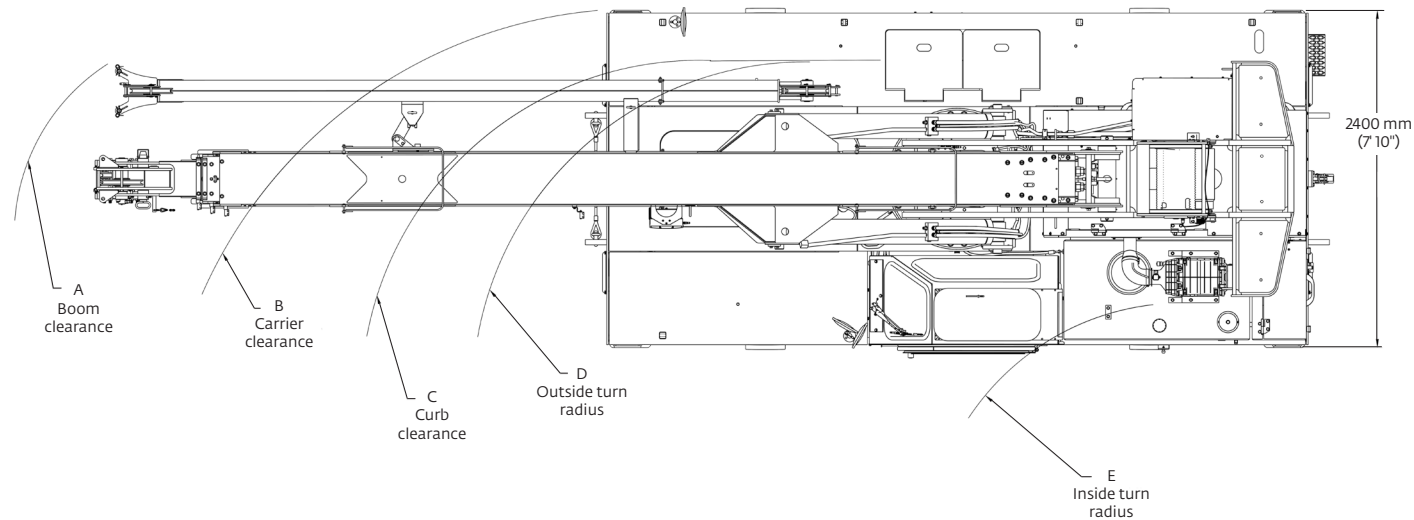

Weights						
	GVW		Front		Rear	
	kg	(lb)	kg	(lb)	kg	(lb)
<b>Basic machine:</b> Including 21,6 m (71 ft) main boom, main hoist with 119 m (390 ft) of wire rope, 22,6 t (25 USt) hookblock, full counterweight, Tier IV engine	20 249	(44,640)	9 904	(21,834)	10 345	(22,806)
<b>Add:</b> 5,1 m (17 ft) fixed swingaway extension and extension carrier brackets and downhaul weight	208	(458)	406	(896)	-199	(-438)
<b>Crane weight</b>	20 456	(45,098)	10 310	(22,730)	10 146	(22,368)
<b>Basic machine:</b> Including 21,6 m (71 ft) main boom, main hoist with 119 m (390 ft) of wire rope, 22,6 t (25 USt) hookblock, full counterweight, Tier IV engine	20 249	(44,640)	9 904	(21,834)	10 345	(22,806)
<b>Add:</b> Enclosed cab with heater and defroster	106	(233)	104	(104)	129	(129)
<b>Crane weight</b>	20 354	(44,873)	9 951	(21,938)	10 403	(22,935)

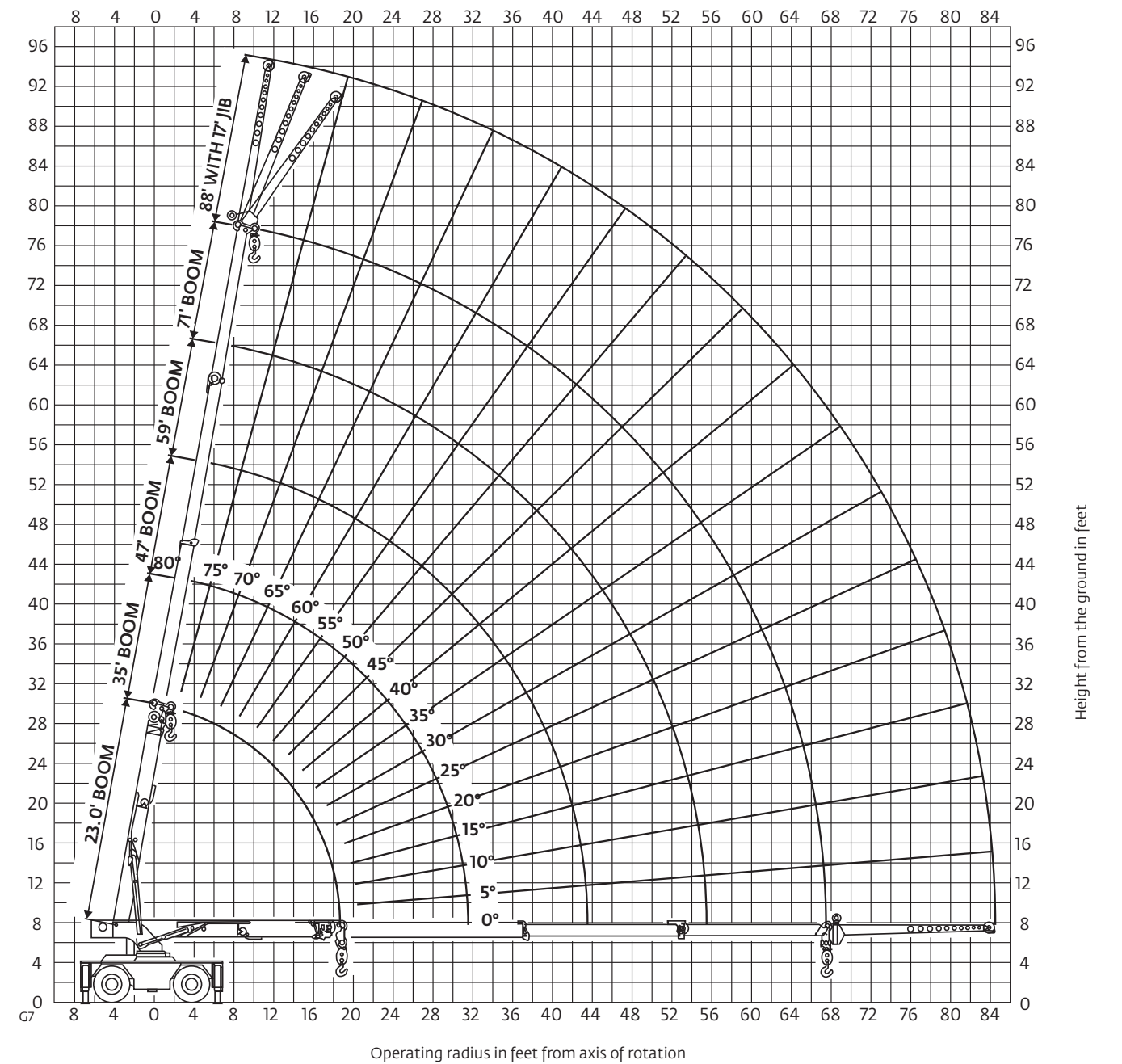

# Load chart

# Load chart

MAIN BOOM LOAD RATINGS ON OUTRIGGERS Extended and Down 360° or Retracted and Down Front/Rear										MAIN BOOM LOAD RATINGS ON OUTRIGGERS Retracted and Down 360°											
23.0 ft Boom		35.0 ft Boom		47.0 ft Boom		59.0 ft Boom		71.0 ft Boom		23.0 ft Boom		35.0 ft Boom		47.0 ft Boom		59.0 ft Boom		71.0 ft Boom			
Radius (ft)	Rated Load (lb)	Rated Angle (deg)	Rated Load (lb)	Rated Angle (deg)	Rated Load (lb)	Rated Angle (deg)	Rated Load (lb)	Rated Angle (deg)	Rated Load (lb)	Radius (ft)	Rated Load (lb)	Rated Angle (deg)	Rated Load (lb)	Rated Angle (deg)	Rated Load (lb)	Rated Angle (deg)	Rated Load (lb)	Rated Angle (deg)	Rated Load (lb)		
8.5	50,000	73.2	34,300	78.1	33,600	79.7	27,800	77.1	16,750	8.5	63.5	26,350	73	24,000	78	21,900	79.5	16,650	79	10,500	
10	38,793	70.6	34,500	76.2	33,017	77.8	25,900	77.1	16,750	10	59	20,800	70.5	19,300	76	17,900	77.5	13,350	79	8,870	
12	34,893	66.9	31,426	73.6	29,285	77.8	25,900	77.1	16,750	12	52.5	16,000	67	15,100	73.5	14,200	77.5	13,350	79	7,590	
14	46.8	63.2	28,464	71	26,357	75.8	24,100	77.7	18,200	14	45.5	12,300	63	12,250	71	11,600	75.5	11,000	79	6,810	
16	38.8	59.2	26,076	68.3	24,016	73.7	22,400	77.1	16,750	16	37	9,850	55.5	10,150	68.5	9,710	73.5	9,280	77	5,590	
18	28.7	55.1	23,496	65.6	22,096	71.7	20,792	75.4	15,500	18	26	8,070	55.5	8,370	65.5	8,230	71.5	7,910	75.5	4,680	
19.5	21,044	51.9	21,379	63.5	20,902	70.1	19,582	74.2	14,650	19.5	0	7,090	52	7,300	63.5	7,330	70	7,060	74	4,680	
22		46	18,471	59.9	18,629	67.4	17,872	72	13,400	22			46.5	5,900	60	6,050	67.5	5,900	72	4,680	
24		40.8	16,592	56.9	16,747	65	16,300	70.3	12,500	24			41.5	5,040	57	5,170	65	5,150	70	3,720	
26		36	14,600	54	14,850	63	14,200	68.5	11,750	26			36	4,330	54	4,450	63	4,520	68.5	4,400	
28		29	12,750	51	13,050	60.5	13,150	66.7	11,050	28			29	3,740	51	3,850	60.5	3,930	66.5	3,880	
30		20	11,250	47.5	11,600	58.5	11,700	65.2	9,800	30			20	3,250	47.5	3,340	58.5	3,410	65	3,420	
31.5		0	10,300	45	10,650	56.5	10,750	63.9	9,400	31.5			0	2,910	45	3,010	56.5	3,080	63.5	3,120	
34				40	9,350	53.5	9,480	61.5	8,850	34					40	2,530	53.5	2,590	61	2,640	
36				36	8,460	51	8,590	59.6	8,400	36					36	2,200	51	2,260	59	2,310	
38				31	7,680	48.5	7,830	57	7,940	38					31	1,910	48.5	1,960	57	2,010	
40				25	7,000	45.5	7,150	55	7,270	40					25	1,660	45.5	1,700	55	1,750	
42				17.5	6,400	42.5	6,550	53	6,680	42					17.5	1,410	42.5	1,470	53	1,510	
43.5				0	6,000	40.5	6,000	51.5	6,270	43.5					0	1,230	40.5	1,310	51.5	1,350	
46						36	5,440	48.5	5,680	46							36	1,070	48.5	1,110	
48						32.5	5,040	46.5	5,250	48							32.5	890	46.5	930	
50						28	4,680	44	4,860	50							28	720	44	780	
52						23	4,350	41.5	4,510	52							23	570	41.5	630	
54						16	4,040	38.5	4,190	54							16	430	38.5	500	
55.5						0	3,820	36.5	3,960	55.5							0	330	36.5	410	
58								32.5	3,620	58									32.5	270	
60									29	3,370	60										
62									25	3,130	62										
64									20	2,920	64										
66									13	2,720	66										
67									0	2,620	67										

Main Boom Angle (deg)	17 ft JIB CAPACITY ON EXTENDED OUTRIGGERS (lb)				
	Jib Offset Angle				30° Any Boom Length
	0°		15°		
To 55 ft Main Boom	To 71 ft Main Boom	To 55 ft Main Boom	To 71 ft Main Boom		
80	—	—	5000	5000	3500
75	7500	—	4400	4400	3100
70	6100	—	3900	3900	2800
65	5000	4600	3500	3500	2550
60	4300	3800	3150	3150	2350
55	3800	3300	2850	2850	2200
50	3400	2900	2600	2600	2100
45	3050	2600	2400	2400	2000
40	2800	2400	2250	2250	1950
35	2600	2150	2150	2050	1900
30	2400	1930	2080	1850	1830
25	2300	1750	2050	1720	—
20	2200	1600	2000	1590	—
15	2100	1500	1950	1520	—
10	2050	1460	—	—	—
5	2020	1450	—	—	—
0	2000	1440	—	—	—

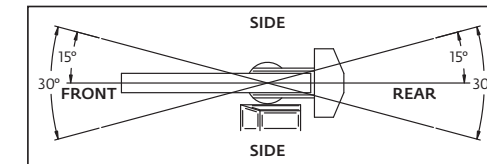

Radius (ft)	MAIN BOOM ON RUBBER	
	Front Rating (lb)	360° Rating (lb)
6	30,000	21,000
8	24,950	17,900
10	21,000	15,000
12	18,000	13,000
14	15,650	10,000
16	13,300	7,920
18	10,900	6,410
20	9,460	5,780
22	8,060	4,880
24	6,960	4,140
26	6,050	3,520
28	5,300	2,990
30	4,670	2,540
32	4,130	2,160
34	3,670	1,820
36	3,260	1,530
38	2,900	1,270
40	2,590	1,040
42	2,300	830
44	2,280	720
46	2,050	610
48	1,840	500
50	1,650	390
52	1,480	280
54	1,320	—
56	1,220	—
58	1,080	—
60	950	—
62	840	—
64	730	—
66	620	—
67	570	—

**NOTES:**  
JIB CAPACITY IS LIMITED BY BOTH STRUCTURAL CAPACITY CHART AND MAIN CAPACITY CHART.

SHADED AREAS ARE GOVERNED BY STRUCTURAL STRENGTH, DO NOT RELY ON TIPPING.

OPERATION OF THIS EQUIPMENT IN EXCESS OF RATING CHARTS AND DISREGARD OF INSTRUCTIONS IS DANGEROUS AND VOIDS WARRANTY.

1) The rated loads are the maximum lift capacities as determined by operating radius, boom length and boom angle. The operating radius is the horizontal distance from a projection of the axis of rotation to the supporting surface, before loading, to the center of vertical hoist line or tackle with load applied.

2) Rated load columns for discrete boom lengths apply when actual boom length is within +/- 1.0 ft of discrete length. When boom length or radius or both are between points listed on capacity chart, the smallest load shown at either the next larger radius or boom length shall be used.

3) For operating radius not shown, use load rating of next larger radius.

4) The rated loads shown on outriggers do not exceed 85% of actual tipping. The rated loads shown on rubber do not exceed 75% of actual tipping. These ratings are based on freely suspended loads with the crane leveled, standing on a firm, uniform supporting surface. Practical working loads depend on supporting surface, operating radius and other factors affecting stability. Hazardous surroundings, climatic conditions, experience of personnel and proper training must all be taken into account by the operator.

RATING REDUCTIONS FOR LOAD HANDLING DEVICES INSTALLED (lb)		
	FROM MAIN BOOM	FROM JIB
MAIN BLOCK	475	N/A
HOOK & BALL	100	100
JIB STOWED	0	N/A
JIB DEPLOYED	500	0

MAXIMUM PERMISSIBLE SINGLE LINE PULL = 12,500 lb  
HOIST ROPE: 5/8 in diameter  
6 x 19 XIPS IWRC BRIGHT  
Min. req'd breaking strength = 45,400 lb

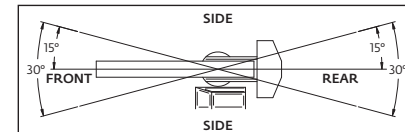

5) The weights of all load handling devices such as hooks, hook blocks, slings, etc., except the hoist rope, shall be considered part of the load. See reduction chart.

6) Ratings on outriggers are for either outriggers fully extended and down or fully retracted and down. Ratings for outriggers fully retracted and down will apply for any intermediate outrigger setting.

7) Ratings on rubber depend on tire capacity, condition of tires and proper inflation pressure (110 psi). When replacing tires, contact Manitowoc for proper specifications. Loads on rubber may be transported at a maximum speed of 2.5 mph on a smooth, hard, level surface with boom retracted to the shortest length possible and centered over front. For 360° ratings on rubber, rear axle oscillation locks must be in place. Do not use jib with crane on rubber.

8) The maximum combined total boom and deck load is 20,000 lb. The maximum deck load only is 30,000 lb.

9) Do not induce any external side loads to boom or jib.

80022135YB

THIS CHART IS ONLY A GUIDE AND SHOULD NOT BE USED TO OPERATE THE CRANE.

The individual crane's load chart, operating instructions and other instructional plates must be read and understood prior to operating the crane.

THIS CHART IS ONLY A GUIDE AND SHOULD NOT BE USED TO OPERATE THE CRANE.

The individual crane's load chart, operating instructions and other instructional plates must be read and understood prior to operating the crane.

# DIN/ISO range diagram

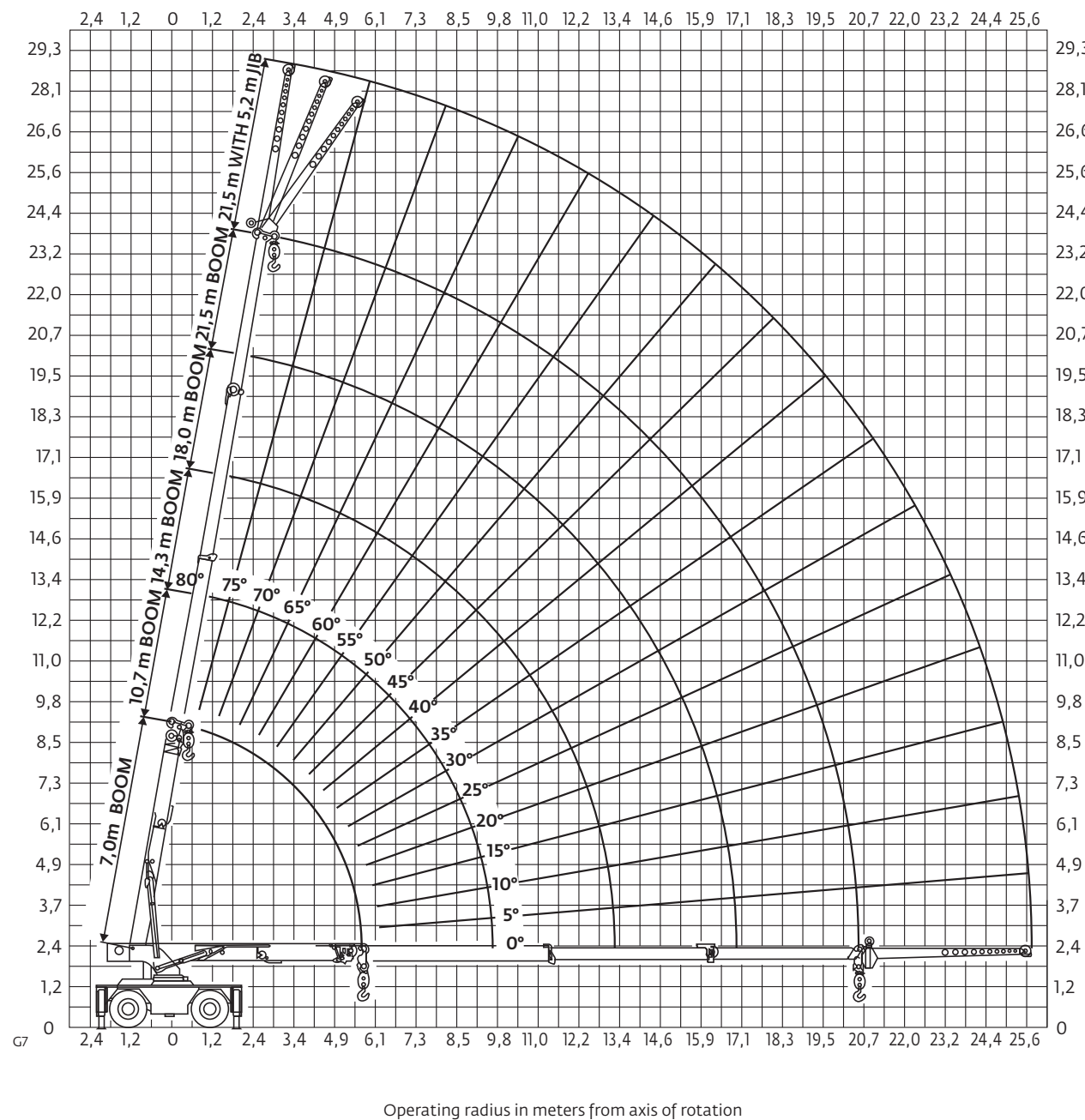

THIS CHART IS ONLY A GUIDE AND SHOULD NOT BE USED TO OPERATE THE CRANE.  
The individual crane's load chart, operating instructions and other instructional plates must be read and understood prior to operating the crane.

# DIN/ISO load chart

MAIN BOOM LOAD RATINGS ON OUTRIGGERS Extended and Down 360° or Retracted and Down Front/Rear										MAIN BOOM LOAD RATINGS ON OUTRIGGERS Retracted and Down 360°											
Radius (m)	7,0 m Boom		10,7 m Boom		14,3 m Boom		18,0 m Boom		21,5 m Boom		Radius (m)	7,0 m Boom		10,7 m Boom		14,3 m Boom		18,0 m Boom		21,5 m Boom	
	Boom Angle (deg)	Rated Load (kg)	Boom Angle (deg)	Rated Load (kg)	Boom Angle (deg)	Rated Load (kg)	Boom Angle (deg)	Rated Load (kg)	Boom Angle (deg)	Rated Load (kg)		Boom Angle (deg)	Rated Load (kg)	Boom Angle (deg)	Rated Load (kg)	Boom Angle (deg)	Rated Load (kg)	Boom Angle (deg)	Rated Load (kg)	Boom Angle (deg)	Rated Load (kg)
2,6	64,5	22 650	73,5	15 550	78,5	15 225	80	12 600			2,6	63,5	10 675	73	9495	78	8490				
3,0	60	17 575	71	15 650	76,5	14 975	78	11 725			3,0	59	8805	70,5	7955	76	7220	79,5	6580		
3,7	54	15 825	67	14 250	74	13 275	78	10 925			3,7	52,5	6625	67	6100	73,5	5640	77,5	5215		
4,3	47	14 175	63,5	12 900	71	11 950	76	10 150	79	8255	4,3	45,5	5390	63	5010	71	4680	75,5	4370	79	4095
4,9	39	12 100	59,5	11 825	68,5	10 875	74	10 150	77,5	7595	4,9	37	4430	59,5	4195	68,5	3950	73,5	3715	77	3505
5,5	29	10 500	55,5	10 650	66	10 000	72	9365	75,5	7030	5,5	26	3645	55,5	3570	65,5	3375	71,5	3190	75,5	3030
5,9	0	9545	52	9695	63,5	9070	70,5	8510	74,5	6645	5,9	0	3245	52	3225	63,5	3055	70	2900	74	2760
6,7	-	-	46	7905	60	7575	67,5	7155	72	6075	6,7	-	-	46,5	2665	60	2535	67,5	2415	72	2305
7,3	-	-	41	6785	57	6715	65	6365	70,5	5670	7,3	-	-	41,5	2295	57	2215	65	2115	70	2025
7,9	-	-	36	5905	54	5965	63	5710	68,5	5330	7,9	-	-	36	1975	54	1945	63	1860	68,5	1785
8,5	-	-	29	5215	51	5205	60,5	5155	67	4945	8,5	-	-	29	1710	51	1715	60,5	1640	66,5	1580
9,1	-	-	20	4640	47,5	4660	58,5	4625	65,5	4445	9,1	-	-	20	1490	47,5	1515	58,5	1450	65	1395
9,6	-	-	0	4255	45	4270	56,5	4240	64	4180	9,6	-	-	0	1320	45	1365	56,5	1310	63,5	1260
10,4	-	-	-	-	40	3725	53,5	3725	61,5	3695	10,4	-	-	-	-	40	1140	53,5	1110	61	1070
11,0	-	-	-	-	36	3380	51	3395	60	3375	11,0	-	-	-	-	36	995	51	980	59	945
11,6	-	-	-	-	31	3080	48,5	3105	57	3090	11,6	-	-	-	-	31	865	48,5	865	57	830
12,2	-	-	-	-	25	2815	45,5	2840	55	2845	12,2	-	-	-	-	25	755	45,5	760	55	730
12,8	-	-	-	-	17,5	2590	42,5	2605	53	2625	12,8	-	-	-	-	17,5	640	42,5	665	53	635
13,3	-	-	-	-	0	2440	40,5	2440	51,5	2465	13,3	-	-	-	-	0	560	40,5	595	51,5	570
14,0	-	-	-	-	-	-	36	2210	48,5	2225	14,0	-	-	-	-	-	-	36	490	48,5	475
14,6	-	-	-	-	-	-	32,5	2040	46,5	2055	14,6	-	-	-	-	-	-	32,5	405	46,5	405
15,2	-	-	-	-	-	-	28	1890	44	1900	15,2	-	-	-	-	-	-	28	330	44	340
15,8	-	-	-	-	-	-	23	1750	41,5	1760	15,8	-	-	-	-	-	-	23	260	41,5	280
16,5	-	-	-	-	-	-	16	1600	38,5	1615	16,5	-	-	-	-	-	-	16	190	38,5	215
16,9	-	-	-	-	-	-	0	1515	36,5	1535	16,9	-	-	-	-	-	-	0	150	36,5	180
17,7	-	-	-	-	-	-	-	-	32,5	1395	17,7	-	-	-	-	-	-	-	-	32,5	115
18,3	-	-	-	-	-	-	-	-	29	1295	18,3	-	-	-	-	-	-	-	-	-	-
18,9	-	-	-	-	-	-	-	-	25	1210	18,9	-	-	-	-	-	-	-	-	-	-
19,5	-	-	-	-	-	-	-	-	20	1125	19,5	-	-	-	-	-	-	-	-	-	-
20,1	-	-	-	-	-	-	-	-	13	1045	20,1	-	-	-	-	-	-	-	-	-	-
20,4	-	-	-	-	-	-	-	-	0	1010	20,4	-	-	-	-	-	-	-	-	-	-

MAIN BOOM ON RUBBER Any Boom Length		
Radius (m)	Front Rating (kg)	360° Rating (kg)
1,8	13 600	9525
2,6	11 300	6875
3,0	9105	5040
3,7	6525	4070
4,3	5530	3445
4,9	4435	2950
5,5	3880	2545
6,1	3425	2210
6,7	3045	1930
7,3	2710	1685
7,9	2350	1480
8,5	2050	1255
9,1	1800	1055
9,8	1550	855
10,4	1365	705
11,0	1205	575
11,6	1065	460
12,2	940	360
12,8	830	265
13,4	820	230
14,0	730	195
14,6	650	160
15,2	570	125
15,8	505	90
16,5	430	-
17,1	390	-
17,7	340	-
18,3	290	-
18,9	240	-
19,5	195	-
20,1	155	-
20,4	135	-

NOTES:  
JIB CAPACITY IS LIMITED BY BOTH STRUCTURAL CAPACITY CHART AND MAIN CAPACITY CHART.

SHADED AREAS ARE GOVERNED BY STRUCTURAL STRENGTH, DO NOT RELY ON TIPPING.

OPERATION OF THIS EQUIPMENT IN EXCESS OF RATING CHARTS AND DISREGARD OF INSTRUCTIONS IS DANGEROUS AND VOIDS WARRANTY.

- The rated loads are the maximum lift capacities as determined by operating radius, boom length and boom angle. The operating radius is the horizontal distance from a projection of the axis of rotation to the supporting surface, before loading, to the center of vertical hoist line or tackle with load applied.
- Rated load columns for discrete boom lengths apply when actual boom length is within +/- 0,3 m of discrete length. When boom length or radius or both are between points listed on capacity chart, the smallest load shown at either the next larger radius or boom length shall be used.
- For operating radius not shown, use load rating of next larger radius.
- The rated loads shown on outriggers do not exceed 85% of actual tipping. The rated loads shown on rubber do not exceed 75% of actual tipping. These ratings are based on freely suspended loads with the crane leveled, standing on a firm, uniform supporting surface. Practical working loads depend on supporting surface, operating radius and other factors affecting stability. Hazardous surroundings, climatic conditions, experience of personnel and proper training must all be taken into account by the operator.

RATING REDUCTIONS FOR LOAD HANDLING DEVICES INSTALLED (kg)		
	FROM MAIN BOOM	FROM JIB
MAIN BLOCK	215	N/A
HOOK & BALL	50	50
JIB STOWED	0	N/A
JIB DEPLOYED	230	0

MAXIMUM PERMISSIBLE SINGLE LINE PULL = 5670 kg

HOIST ROPE: 16 mm diameter  
8 x 26 XIPS IWRC BRIGHT  
Min. req'd breaking strength = 258,9 kN

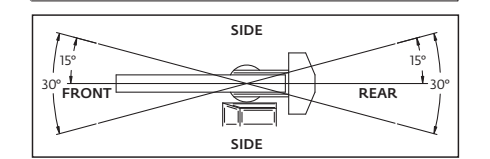

- The weights of all load handling devices such as hooks, hook blocks, slings, etc., except the hoist rope, shall be considered part of the load. See reduction chart.
- Ratings on outriggers are for either outriggers fully extended and down or fully retracted and down. Ratings for outriggers fully retracted and down will apply for any intermediate outrigger setting.
- Ratings on rubber depend on tire capacity, condition of tires and proper inflation pressure (7.6 bar). When replacing tires, contact Manitowoc for proper specifications. Loads on rubber may be transported at a maximum speed of 4,0 km/h on a smooth, hard, level surface with boom retracted to the shortest length possible and centered over front. For 360° ratings on rubber, rear axle oscillation locks must be in place. Do not use jib with crane on rubber.
- The maximum combined total boom and deck load is 9070 kg. The maximum deck load only is 13 610 kg.
- Do not induce any external side loads to boom or jib.

5,2 m JIB CAPACITY ON EXTENDED OUTRIGGERS (kg)					
Main Boom Angle (deg)	Jib Offset Angle				30° Any Boom Length
	0°		15°		
	To 18,0 m Main Boom	To 21,5 m Main Boom	To 18,0 m Main Boom	To 21,5 m Main Boom	
80	—	—	2270	2270	1590
75	3400	—	2000	2000	1410
70	2770	—	1770	1770	1270
65	2270	2090	1590	1590	1160
60	1950	1720	1430	1430	1070
55	1720	1500	1290	1290	1000
50	1540	1320	1180	1180	0950
45	1380	1180	1090	1090	0910
40	1270	1090	1020	1020	0880
35	1180	0980	0980	0930	0860
30	1090	0880	0940	0840	0830
25	1040	0790	0930	0780	—
20	1000	0730	0910	0720	—
15	0950	0680	0880	0690	—
10	0930	0660	—	—	—
5	0920	0660	—	—	—
0	0910	0650	—	—	—

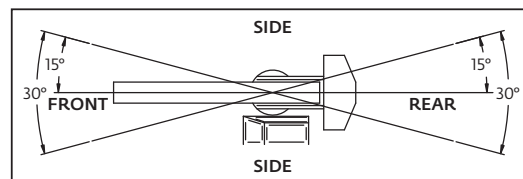

1) The rated loads are the maximum lift capacities as determined by operating radius, boom length and boom angle. The operating radius is the horizontal distance from a projection of the axis of rotation to the supporting surface, before loading, to the center of vertical hoist line or tackle with load applied.

2) Rated load columns for discrete boom lengths apply when actual boom length is within +/- 0,3 m of discrete length. When boom length or radius or both are between points listed on capacity chart, the smallest load shown at either the next larger radius or boom length shall be used.

3) For operating radius not shown, use load rating of next larger radius.

4) The rated loads shown on outriggers do not exceed 85% of actual tipping. The rated loads shown on rubber do not exceed 75% of actual tipping. These ratings are based on freely suspended loads with the crane leveled, standing on a firm, uniform supporting surface. Practical working loads depend on supporting surface, operating radius and other factors affecting stability. Hazardous surroundings, climatic conditions, experience of personnel and proper training must all be taken into account by the operator.

5) The weights of all load handling devices such as hooks, hook blocks, slings, etc., except the hoist rope, shall be considered part of the load. See reduction chart.

6) Ratings on outriggers are for either outriggers fully extended and down or fully retracted and down. Ratings for outriggers fully retracted and down will apply for any intermediate outrigger setting.

7) Ratings on rubber depend on tire capacity, condition of tires and proper inflation pressure (7.6 bar). When replacing tires, contact Manitowoc for proper specifications. Loads on rubber may be transported at a maximum speed of 4,0 km/h on a smooth, hard, level surface with boom retracted to the shortest length possible and centered over front. For 360° ratings on rubber, rear axle oscillation locks must be in place. Do not use jib with crane on rubber.

8) The maximum combined total boom and deck load is 9070 kg. The maximum deck load only is 13 610 kg.

9) Do not induce any external side loads to boom or jib.

80024905YB

## TRANSPORTATION AND LIFTING DATA - YB7725

- LIFTING OF ENTIRE CRANE OR MAJOR CRANE ASSEMBLIES MUST BE ACCOMPLISHED BY UTILIZING SPECIFIC FITTINGS INDICATED ON ADJACENT CHART. USE OF FITTINGS FOR PURPOSES OTHER THAN THOSE DESIGNATED ON CHART IS PROHIBITED. FITTING CAPACITIES ARE MAXIMUM ALLOWABLE LOADS PER INDIVIDUAL FITTING.
- RIGGING PERSONNEL SHALL BE RESPONSIBLE FOR PROPER SELECTION AND PLACEMENT OF ALL SLINGS AND LOAD HANDLING DEVICES.
- DIMENSIONS AND WEIGHTS SHOWN ARE ESTIMATED FOR LARGEST CONFIGURATION AVAILABLE. WEIGHTS DO NOT INCLUDE BOOM EXTENSION AND OR JIB, UNLESS OTHERWISE INDICATED.
- RIGGING PERSONNEL SHALL VERIFY DIMENSIONS AS REQUIRED FOR CLEARANCE.
- DO NOT USE COUNTERWEIGHT LIFT LOCATIONS OR BOOM SLING POINT FOR LIFTING OR TIE DOWN OF ENTIRE CRANE.
- LIFTING OF THE COUNTERWEIGHT TO BE ACCOMPLISHED WITH A PROPERLY RATED 1/2 INCH EYEBOLT.

FITTING	NO. / UNIT	LIFT	TOW	TIE DOWN	BOOM LIFT	CWT LIFT	CAPACITY-TONNES [TONS]				
							LIFT	TOW	TIE DOWN		
									FORE & AFT	SIDE	DOWN
A	4	X	X	X			9.1 [10]	27.2 [30]	27.2 [30]	0.9 [1]	27.2 [30]
B	4				X		1.8 [2]				
C	1					X	0.9 [1]				
D	1					X	0.9 [1]				

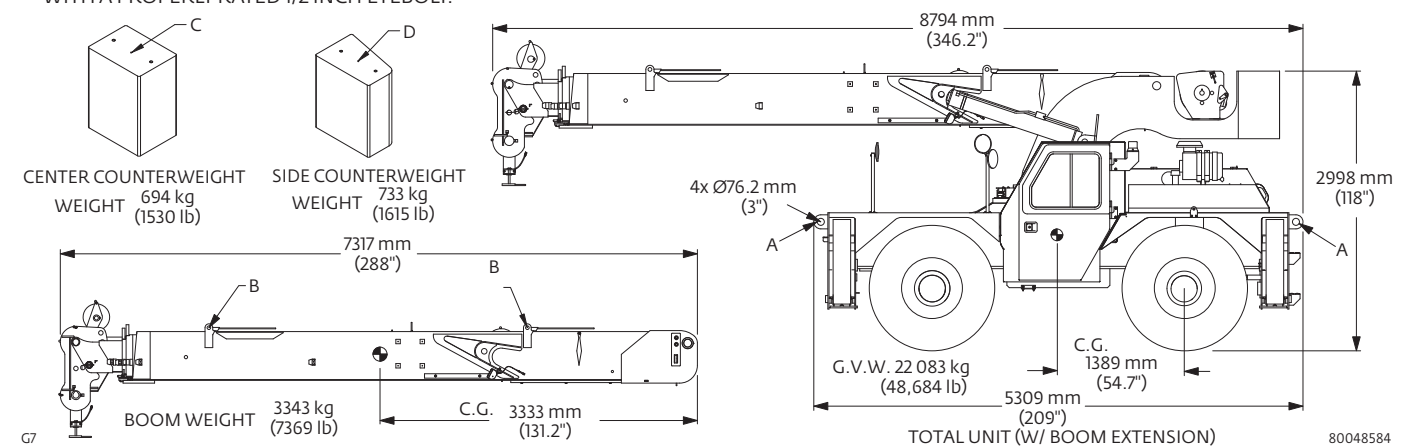

## LOAD DISTRIBUTION CHART

AREA 1	
5,21 m sq (56.1 sq ft)	8981 kg (19,800 lb)
AREA 2	
2,41 m sq (25.9 sq ft)	4627 kg (10,200 lb)



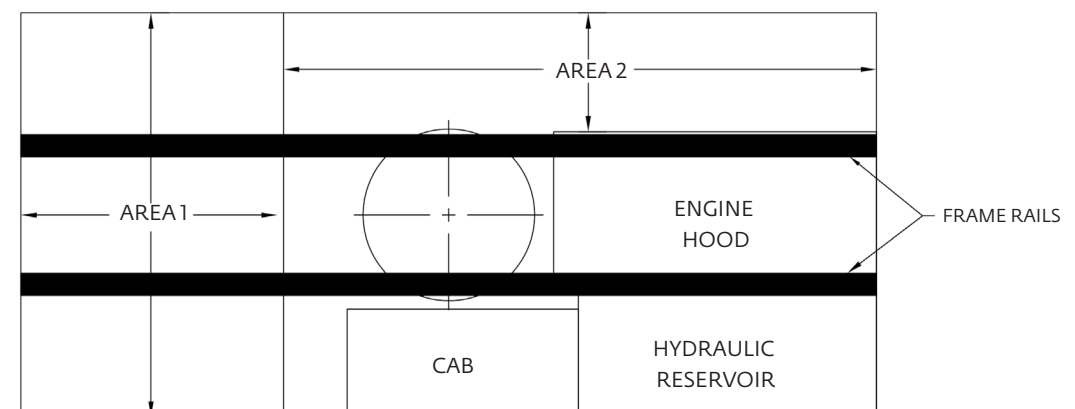



























- Maximum travel speed with any or all loads - 4,0 km/h (2.5 mph)
- Loads to be transported on smooth level surfaces only.
- Boom must be retracted and in center forward position.
- Any combination or total of areas 1 and 2 may be used.
- Lifting is not permitted when carry deck is loaded except for loading and unloading carry deck.
- Rated pick and carry loads may be transported on deck area 1 provided the load is cribbed directly on the frame rails.





# Symbols glossary

# Notes

 Axles	 Counterweight	 Grade	 Outriggers
 Boom	 Drive	 Heavy duty jib	 Radius
 Boom elevation	 Electrical system	 Hoist	 Rotation
 Boom extension	 Engine	 Hookblock	 Speed
 Boom length	 Extension	 Hydraulic system	 Steering
 Boom nose	 Frame	 Lights	 Suspension
 Brakes	 Fuel tank capacity	 Oil	 Swing
 Cab	 Gear	 Outrigger controls	 Tires
			 Transmission



## Manitowoc Cranes

### Regional headquarters

#### Americas

**Manitowoc, Wisconsin, USA**

Tel: +1 920 684 6621

Fax: +1 920 683 6277

**Shady Grove, Pennsylvania, USA**

Tel: +1 717 597 8121

Fax: +1 717 597 4062

#### Europe, Middle East, Africa

**Ecully, France**

Tel: +33 (0)4 72 18 20 20

Fax: +33 (0)4 72 18 20 00

#### China

**Shanghai, China**

Tel: +86 21 6457 0066

Fax: +86 21 6457 4955

#### Greater Asia-Pacific

**Singapore**

Tel: +65 6264 1188

Fax: +65 6862 4040

### Regional offices

#### Americas

**Brazil**

Alphaville

**Mexico**

Monterrey

**Chile**

Santiago

#### Europe, Middle East,

**Africa**

**Czech Republic**

Netvorice

**France**

Baudemont

Cergy

Decines

**Germany**

Langenfeld

**Hungary**

Budapest

**Italy**

Lainate

**Netherlands**

Breda

**Poland**

Warsaw

**Portugal**

Baltar

**Russia**

Moscow

**South Africa**

Johannesburg

**U.A.E.**

Dubai

**U.K.**

Buckingham

#### China

Beijing

Chengdu

Guangzhou

Xian

#### Greater Asia-Pacific

**Australia**

Brisbane

Melbourne

Sydney

**India**

Chennai

Delhi

Hyderabad

Pune

**Korea**

Seoul

**Philippines**

Makati City

**Singapore**

### Factories

**Brazil**

Passo Fundo

**China**

TaiAn

Zhangjiagang

**France**

Charlieu

Moulins

**Germany**

Wilhelmshaven

**India**

Pune

**Italy**

Niella Tanaro

**Portugal**

Baltar

Fânzeres

**Slovakia**

Saris

**USA**

Manitowoc

Port Washington

Shady Grove

This document is non-contractual. Constant improvement and engineering progress make it necessary that we reserve the right to make specification, equipment, and price changes without notice. Illustrations shown may include optional equipment and accessories and may not include all standard equipment.