

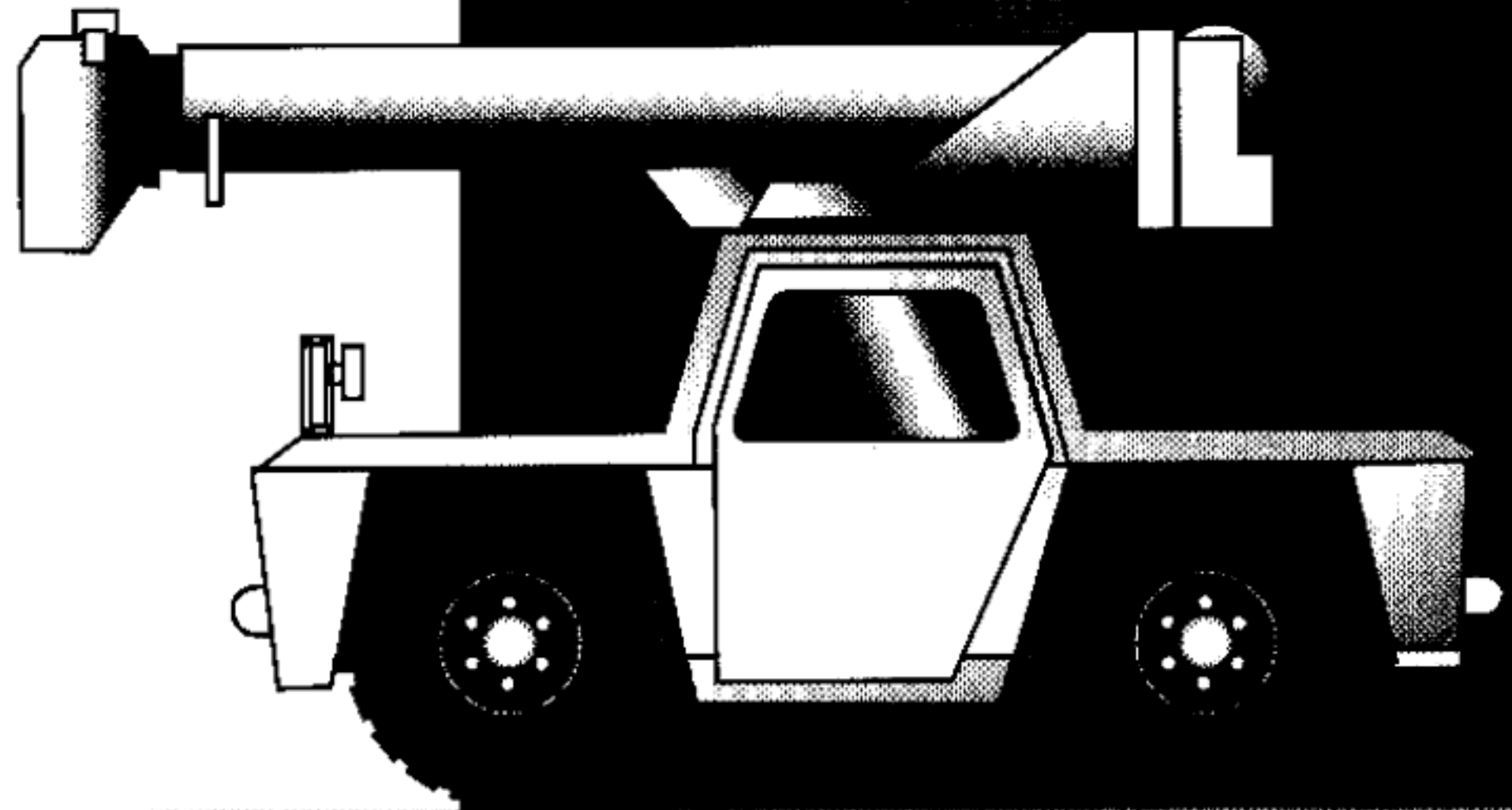

**GROVE**  
**CRANE**

A GROVE WORLDWIDE COMPANY

# AP308



**Material Handling Hydraulic Crane**

# Dimensions

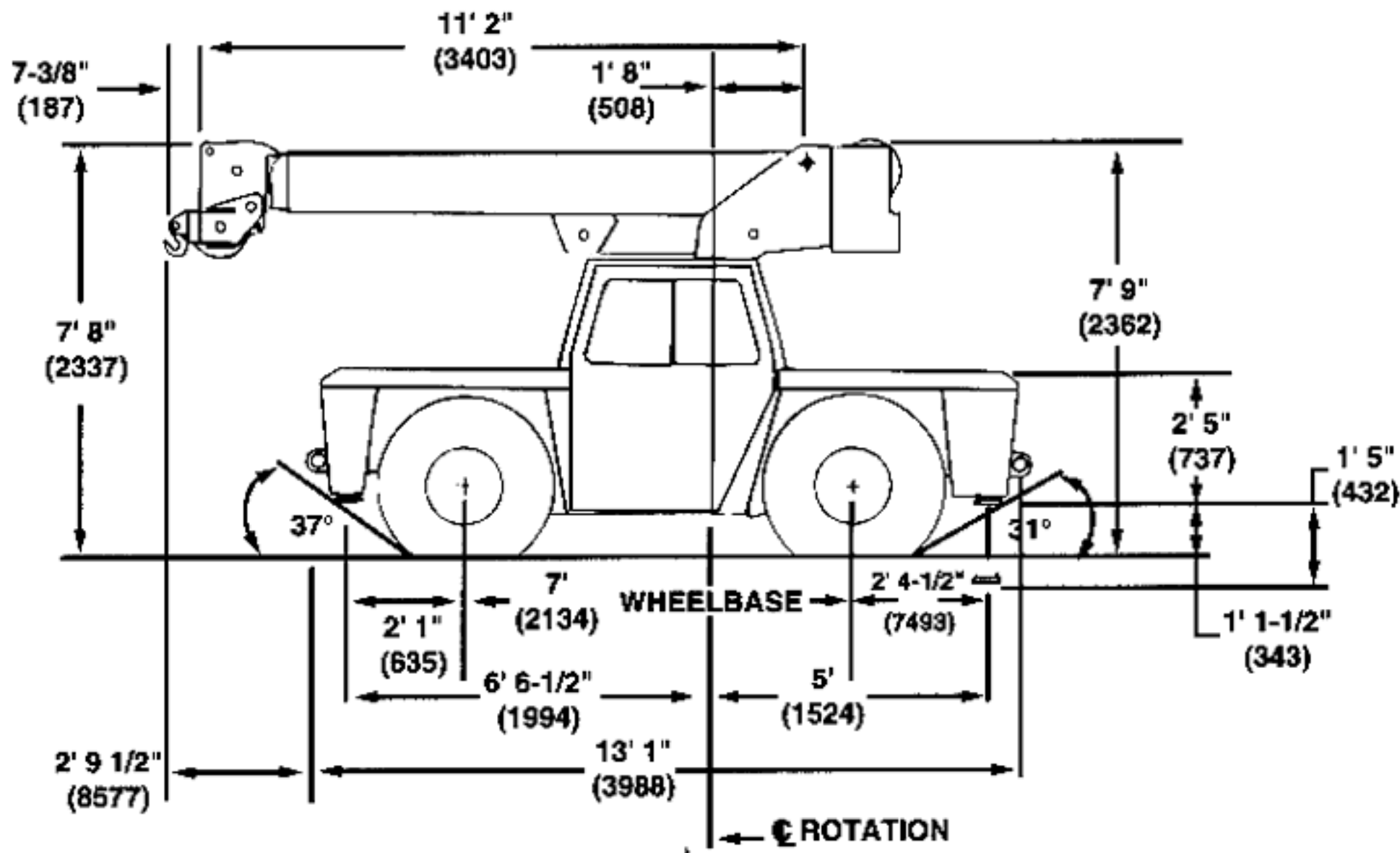
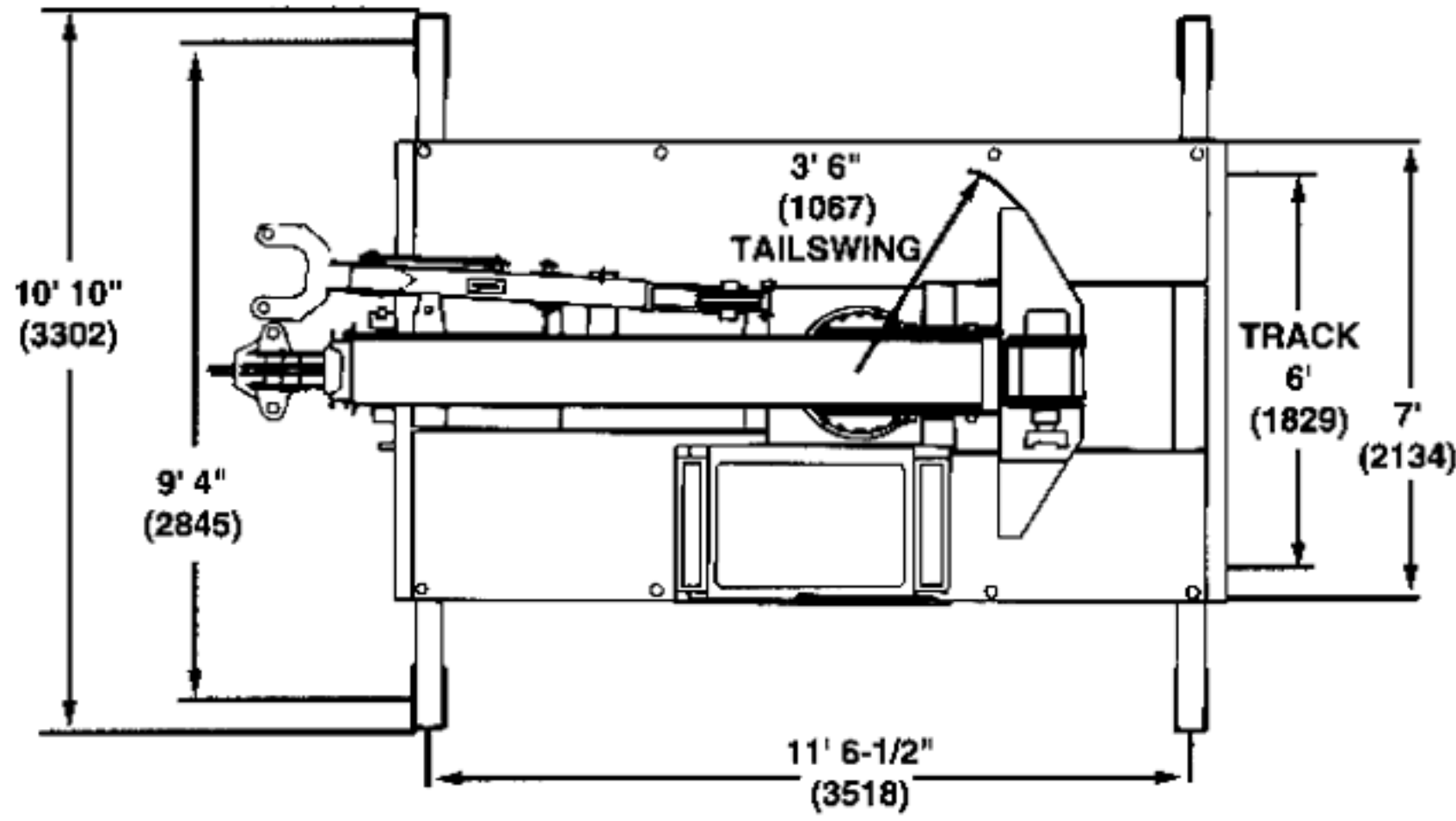

Turning Radius	15' 9" (4668 mm)
Front Axle Load	6,731 lbs. (3053 kg)
Rear Axle Load	8,730 lbs. (3960 kg)
Gross Vehicle Weight	15,461 lbs. (7013 kg)

# Working Range



10.5 - 24 ft.  
(3.2 - 7.3 m)



10 - 15 ft. 9 in.  
(3.05 - 4.8 m)

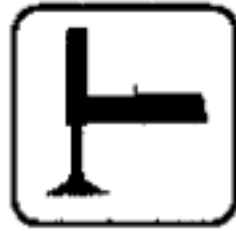

360°

FEET

60

50

40

30

20

10

0

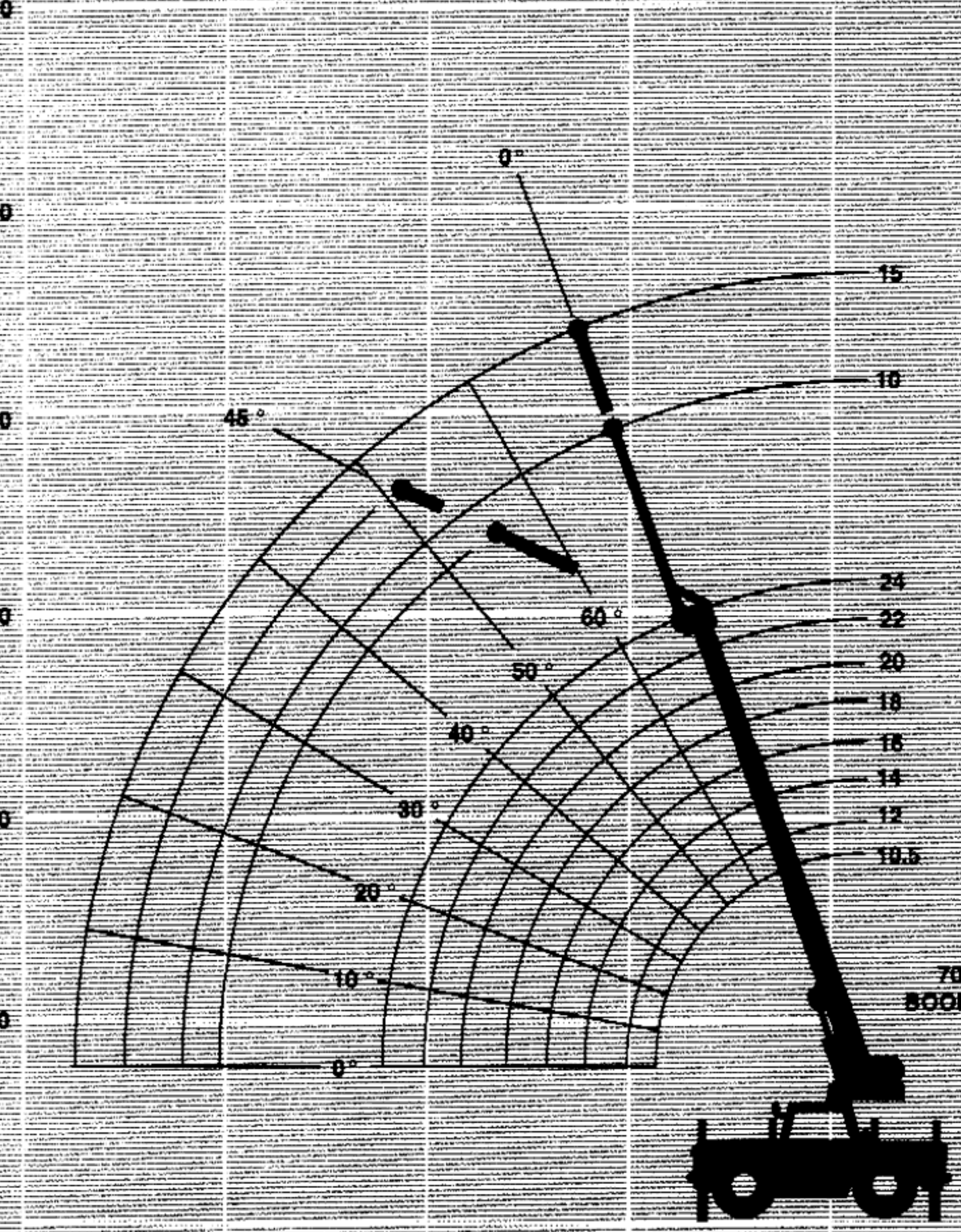

70° MAX  
BOOM ANGLE

FEET  
←  
AXIS  
OF  
ROTATION

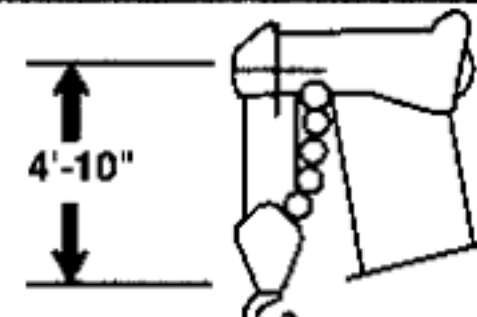
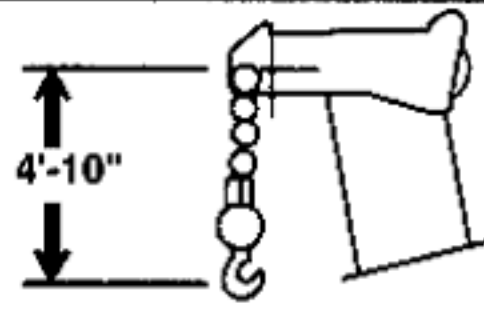

DIMENSIONS ARE FOR LARGEST GROVE FURNISHED HOOK BLOCK AND HEADACHE BALL, WITH ANTI-TWO BLOCK ACTIVATED.

# Superstructure specifications

## Boom

10.5 ft. - 24 ft. (3.2 m - 7.3 m) three-section full power boom.

Maximum tip height: 29 ft. (8.8 m).

## Fixed Swingaway Extension

10 ft. (3.05 m) swingaway extension. Offsettable at 0° or 45°. Stows alongside base boom section.

Maximum tip height: 39 ft. (11.9 m).

## \*Optional Telescopic Swingaway Extension

10 ft. - 15 ft. (3.05 m - 4.5 m) telescoping swingaway extension. Offsettable at 0° or 45°. Stows alongside base boom section.

Maximum tip height: 44 ft. (13.4 m).

## Boom Nose

Two lower steel sheaves and one idler sheave mounted on bronze bushings with removable pin-type rope guards.

## \*Optional Searcher Hook

Boom nose mounted. 3,000 lbs. (1316 kg) capacity.

## Boom Elevation

One double acting hydraulic cylinder with integral holding valve provides elevation from 0° to 70°.

## Load Moment & Anti-Two Block System

Standard load moment and anti-two block system with audio-visual warning and control lever lockout. These systems provide electronic display of boom angle, length, radius, tip height, relative load moment, maximum permissible load and load indication and warning of impending two-block condition.

## Cab

Standard frame mounted control station includes all crane function and driving controls, engine monitoring instrumentation and deluxe fabric seat with seat belt. Standard full vision, all steel fabricated enclosed cab with tinted safety glass throughout. Dash panel incorporates gauges for engine functions. Other features include skylight, sliding left & right side windows, electric windshield washer-wiper, circulating air fan and fire extinguisher.

## Swing

Ball bearing swing circle with 360° continuous rotation. Grove planetary glide-swing with automatic type multi-disc brake.

Maximum speed: 1.5 RPM.

## Counterweight

2,100 lbs. (952 kg) integral with superstructure.

## Hydraulic System

Two main gear pumps with a combined capacity of 54.4 GPM (205.7 LPM), driven by carrier engine through PTO.

Two individual valve banks.

Return line type filter with full flow by-pass protection and service indicator. Three micron rated replaceable cartridge.

30 gallon (114 L) reservoir.

Remote-mounted oil cooler with thermostatically controlled electric motor driven fan.

System pressure test ports with quick release type fittings for each circuit.

## HOIST SPECIFICATIONS

### Main Hoist

Planetary reduction with automatic spring applied multi-disc brake, hoist drum cable followers and wire rope.

Maximum Single Line Pull: 9,580 lbs.  
(4345 kg)

Maximum Single Line Speed: 145 FPM  
(44 m/min)

Maximum Permissible Line Pull: 7,400 lbs.  
(3356 kg)

Rope Diameter: 9/16 in.  
(14 mm)

Rope Length: 130 ft.  
(39.6 m)

Maximum Rope Stowage: 181 ft.  
(55.2 m)

\*Denotes optional equipment

# Carrier specifications

## Chassis

High strength alloy steel construction with integral outrigger housings and front/rear lifting, towing and tie down lugs. Carry deck with surface area of 62 sq. ft. (5.8 m<sup>2</sup>).

## Outrigger System

Front and rear oblique type telescoping beams at all four corners with integral holding valves. Outrigger pads are an integral part of the beam and have a surface area of 72 sq. in. (464 cm<sup>2</sup>).

Maximum outrigger pad load: 15,000 lbs. (6804 kg).

## Outrigger Controls

Controls and crane level indicator located in cab.

## Engine

Cummins 4B3.9L diesel, four cylinders, 76 bhp (57 kW) (Gross) @ 2,500 RPM.

Maximum torque: 184 ft. lbs. (250 Nm) @ 1,200 RPM.

## \*Optional Engine

Continental TM 2.7 L, four cylinders, 2.7 L gasoline engine, 66 bhp (49 kW) (Gross) @ 2,800 RPM.

Maximum torque: 144 ft. lbs. (195 Nm) @ 1,800 RPM.

## Fuel Tank Capacity

30 gallons (114 L)

## Transmission

Automatic with 3 speeds forward and 1 reverse with torque converter.

## Electrical System

One 12 V - maintenance free battery. 12 V starting.

## Drive

4 x 2

## Steering

Rear: Full hydraulic power, controlled by steering wheel.

## Axles

Front: Drive-type with no spin differential and planetary reduction hubs rigid mounted to chassis.

Rear: Steer-type rigid mounted to frame.

## Brakes

Hydraulic drum and shoe type acting on front drive wheels. Mechanical hand lever actuated parking brake.

## Tires

10.00 x 15-16 PR tube type, deep mine lug.

## Lights

Full lighting package including turn indicators, head, tail, brake and hazard warning lights.

## Maximum Speed

17 MPH (27 kph) with automatic transmission.

\*29 MPH (46.7 kph) with manual transmission.

## Gradeability (Theoretical)

65.6% (Based on 15,461 lbs. [7013 kg] GVW).

## Miscellaneous Standard Equipment

Dual rear view mirrors, hookblock tiedown sling, electronic back-up alarm, light package and stowage well.

## \*Optional Equipment

- \* Worklights
- \* 360° Flashing light
- \* Cab spotlight
- \* Tachometer
- \* Cold start aid (less canister)
- \* Engine block heater
- \* Maintenance platform
- \* Hookblocks
- \* Tow winch
- \* Tool kit
- \* Pintle hook front/rear
- \* Carry deck posts
- \* LP gas conversion kit (less bottle)
- \* Engine low oil pressure/high water temperature A/V warning system
- \* Spark arrestor muffler
- \* Sound suppression kit
- \* Hot water heater and forced air defroster
- \* Optional hydraulic brakes acting on all four wheels.
- \* Manual Transmission 4 + 4

*\*Denotes optional equipment*



10 - 24 ft.  
(3.2 - 7.3 m)



2,100 lbs.  
(952 kg)



100%



85% Domestic (Pounds)

(Feet)	Over Front	360°
5	17,000	17,000
6	15,000	15,000
8	13,000	13,000
10	11,000	11,000
12	9,500	9,500
14	8,100	7,180
16	6,900	6,740
18	5,900	4,750
20	5,180	4,040
22	4,590	3,500

A6-829-007960A



10 - 24 ft.  
(3.2 - 7.3 m)



2,100 lbs.  
(952 kg)



Rubber  
10.00 x 15 - 16 PR



75% Domestic (Pounds)

(Feet)	Stationary Capacity Defined Arc Over Front	Stationary Capacity 360° Arc	Pick & Carry Capacity Up to 2.5 MPH Boom Centered Over Front
4	15,000	14,700	15,000
5	13,800	10,600	13,800
6	12,450	9,280	12,450
7	11,100	7,380	11,100
8	10,000	5,920	10,000
10	7,920	4,170	7,920
12	6,650	3,180	5,680
14	4,450	2,500	4,450
16	3,620	2,040	3,620
18	2,920	1,700	2,920
20	2,480	1,430	2,480
22	2,130	1,220	2,130

A6-829-013927A

THIS CHART IS ONLY A GUIDE AND SHOULD NOT BE USED TO OPERATE THE CRANE. The individual crane's load chart, operating instructions and other instructional plates must be read and understood prior to operating the crane.



10 - 24 ft.  
(3.2 - 7.3 m)



2,100 lbs.  
(952 kg)



100%



85% Domestic (Pounds)

360°

Over Front



(Feet)

10 ft. Ext.

15 ft. Tele. Ext.

10 ft. Ext.

15 ft. Tele. Ext.

0°

45°

0°

45°

0°

45°

0°

45°

8

7,000

7,000

10

6,500

4,150

6,500

4,150

12

6,000

3,800

6,000

3,800

14

5,500

4,500

3,400

5,500

4,500

3,400

16

5,000

4,200

3,150

5,000

4,200

3,150

18

4,500

3,900

2,950

2,600

4,500

3,900

2,950

2,600

20

4,110

3,600

2,800

2,550

4,200

3,600

2,800

2,550

22

3,480

3,350

2,650

2,500

3,700

3,350

2,650

2,500

24

2,880

2,980

2,550

2,450

3,500

3,160

2,550

2,480

26

2,590

2,590

2,500

2,400

3,250

3,000

2,500

2,400

28

2,260

2,480

2,480

2,250

3,000

2,450

2,450

2,250

30

1,980

2,170

2,170

2,100

2,760

2,350

2,350

2,100

32

1,750

1,850

1,850

2,480

2,200

34

1,720

2,000

36

1,540

1,800

38

1,380

1,800

A6-829-009831A

A6-829-009911A

THIS CHART IS ONLY A GUIDE AND SHOULD NOT BE USED TO OPERATE THE CRANE. The individual crane's load chart, operating instructions and other instructional plates must be read and understood prior to operating the crane.



10 - 24 ft.  
(3.2 - 7.3 m)



2,100 lbs.  
(952 kg)



Rubber  
10.00 x 15 - 16 PR



75% Domestic (Pounds)

360°

Defined Arc Over Front



(Feet)

10 ft. Ext.

15 ft. Tele. Ext.

10 ft. Ext.

15 ft. Tele. Ext.

0°

45°

0°

45°

0°

45°

0°

45°

8

8,110

7,000

10

4,260

4,150

6,500

4,150

12

3,190

3,430

6,000

3,800

14

2,490

2,490

2,700

4,570

4,500

3,400

16

2,010

2,010

2,180

3,830

3,830

3,180

18

1,640

1,640

1,790

1,790

2,970

2,970

2,950

2,600

20

1,360

1,360

1,500

1,500

2,480

2,480

2,550

2,550

22

1,140

1,140

1,260

1,260

2,100

2,100

2,180

2,180

24

960

960

1,070

1,070

1,800

1,800

1,880

1,880

26

810

810

910

910

1,560

1,560

1,650

1,650

28

680

780

780

1,380

1,450

1,450

30

580

660

660

1,180

1,280

1,280

32

480

560

560

1,040

1,140

1,140

34

480

1,020

36

400

910

38

330

810

A6-829-009832B

A6-829-009917B

THIS CHART IS ONLY A GUIDE AND SHOULD NOT BE USED TO OPERATE THE CRANE. The individual crane's load chart, operating instructions and other instructional plates must be read and understood prior to operating the crane.



# Rated Lifting Capacities

## IMPORTANT NOTES:

**WARNING: THIS CHART IS ONLY A GUIDE.**  
 The notes below are for illustration only and should not be relied upon to operate the crane. The individual crane's load chart, operating instructions and other instruction plates must be read and understood prior to operating the crane.

1. All rated loads have been tested to and meet minimum requirements of SAE J1063 NOV93 - Cantilevered Boom Crane Structures - Method of Test, and do not exceed 85% of the tipping load on outriggers fully extended and 75% tipping on rubber, as determined by SAE J765 OCT90 Crane Stability Test Code.

2. Rated loads include the weight of hookblock, slings and auxiliary lifting devices and their weights shall be subtracted from the listed rating to obtain the net load to be lifted. When more than the minimum required hoist reeving is used, the additional rope weight shall be considered part of the load to be handled.

3. Defined Arc  $\pm 6^\circ$  on either side of longitudinal centerline of machine.

4. Capacities appearing above the bold line are based on structural strength and tipping should not be relied upon as a capacity limitation.





































5. All capacities are for crane on firm, level surface. It may be necessary to have structural supports under the outrigger floats or tires to spread the load to a larger bearing surface.

6. When either boom length or radius or both are between values listed, the smallest load shown at either the next larger radius or boom length shall be used.

7. Tires shall be inflated to the recommended pressure before lifting on rubber.

8. For outrigger operation, ALL outriggers shall be properly extended with tires raised free of ground before raising the boom or lifting loads.

## Symbols Glossary

	Frame		Steering
	Outriggers		Transmission
	Outrigger Controls		Axles
	Engine		Brakes
	Fuel Tank Capacity		Tires
	Electrical System		Suspension
	Drive		360° Rotation
	Lights		Boom Elevation
	Cab		Swing
	Boom		Counterweight
	Fixed Swingaway		Oil
	Tails Swingaway		Hydraulic System
	Jib		Rafat
	Boom Nose		Radius
	Boom Extension		Boom Length
	Speed		Hookblock
	Grade		Gear
	Lattice Extension		Lifting Jib

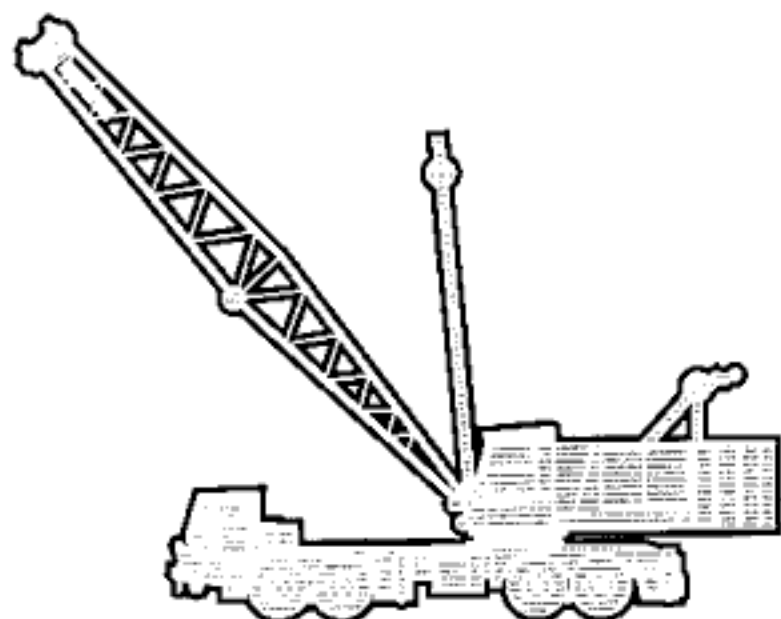

**Grove Worldwide - World Headquarters**

**Grove North America**  
1565 Buchanan Trail East  
P.O. Box 21  
Shady Grove, Pennsylvania 17256, U.S.A.  
Tel: [Int + 1] (717) 597-8121  
Fax: [Int + 1] (717) 597-4062  
Western Hemisphere, Asia/Pacific

**Grove Asia/Pacific - Regional Office**

171 Chin Swee Road  
#06-01 San Centre  
Singapore 0316  
Tel: [Int + 65] 536-6112  
Fax: [Int + 65] 536-6119  
Asia/Pacific, Near East

**Grove Europe Limited\***

Sunderland SR4 6TT, England  
Tel: [Int + 44] 191 565-6281  
Fax: [Int + 44] 191 564-0442  
Europe, Africa, Middle East

**Grove China - Representative Office**

Beijing Hotel Room 6074  
No. 33 East Chang An Avenue  
Beijing, 100004, China  
Tel: [Int + 86] (10) 513-7766  
Fax: [Int + 86] (10) 513-7307

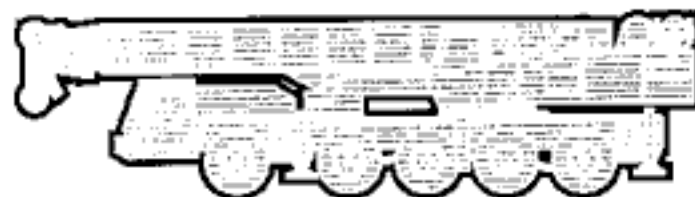

**Grove Europe Limited\***

P.O. Box No. 268  
4A Kimber Road  
Abingdon, Oxfordshire, OX14 1SG  
Tel: [Int + 44] 1235 55-3184  
Fax: [Int + 44] 1235 55-3218

**Grove Product Support**

Western Hemisphere, Asia/Pacific  
1086 Wayne Avenue  
Chambersburg, Pennsylvania USA  
Tel: [Int + 1] (717) 263-5100  
Fax: [Int + 1] (717) 267-0404



**Deutsche Grove GmbH**

**Sales and Service**  
Helmholtzstrasse 12, Postfach 5026  
D-40750 Langenfeld, Germany  
Tel: [Int + 49] (2173) 8909-0  
Fax: [Int + 49] (2173) 8909-30

Europe, Africa, Middle East  
Sunderland SR4 6TT, England  
Tel: [Int + 44] 191 565-6281  
Parts Fax: [Int + 44] 191 510-9242  
Service Fax: [Int + 44] 191 510-9560

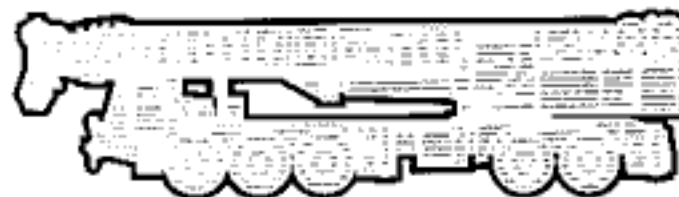

**Wilhelmshaven Works**

Industriegelände West, Postfach 1853  
D-26358 Wilhelmshaven, Germany  
Tel: [Int + 49] (4421) 294-0  
Fax: [Int + 49] (4421) 294-301

**Grove France S.A.**

16, chaussée Jules-César, 95520 OSNY  
B.P. 203, 95523 CERGY PONTOISE CEDEX  
France  
Tel: [Int + 33] (1) 30313150  
Int: [Int + 33] (1) 30386085

\*Grove Europe Limited, Registered in England,  
Number 1845128, Registered office, Crown Works,  
Pallion, Sunderland, Tyne & Wear, England SR4 6TT



Constant improvement and engineering progress make it necessary that we reserve the right to make specification, equipment, and price changes without notice. Illustrations shown may include optional equipment and accessories and may not include all standard equipment.



Distributed By:

